



## **TORNILLERÍA**



## TORNILLOS Y PERNOS

### TORNILLO HEXAGONAL ROSCA COMPLETA

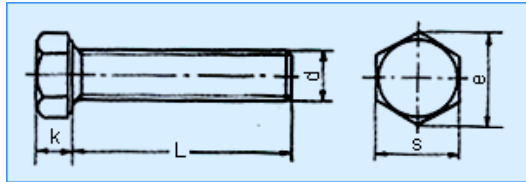
**DIN 933**

GRADO DE RESISTENCIA
8.8
10.9
12.9

Rosca	M4	M5	M6	M8	M10	M12	M14	M16	M18	M20	M22	M24	M27	M30
Paso	0.7	0.8	1	1.25	1.5	1.75	2	2	2.5	2.5	2.5	3	3	3.5
k	2.8	3.5	4	5.3	6.4	7.5	8.8	10	11.5	12.5	14	15	17	18.7
e	Grado A	7.66	8.79	11.05	14.38	18.9	24.49	26.75	30.14	33.53	35.72	35.98	45.2	50.85
	Grado B	-	8.63	10.89	14.2	18.72	23.91	26.17	29.56	32.95	35.03	39.55	45.2	50.85
S	7	8	10	13	17	19	22	24	27	30	32	36	41	46
L	8-40	8-40	8-50	12-60	16-60	20-80	25-80	30-100	30-100	40-100	50-100	50-100	60-100	70-100

mm

### TORNILLO HEXAGONAL ROSCA COMPLETA

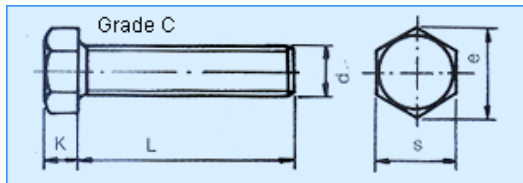
**DIN 558**

GRADO DE RESISTENCIA
8.8

Rosca	M5	M6	M8	M10	M12	M16	M20	M24	M30	M36
Paso	0.8	1	1.25	1.5	1.75	2	2.5	3	3.5	4
k	3.5	4	5.3	6.4	7.5	10	12.5	15	18.7	22.5
e	8.63	10.89	14.2	18.72	20.88	26.17	32.95	39.55	50.85	60.79
S	8	10	13	17	19	24	30	36	46	55
L	10-40	12-50	16-65	16-80	20-100	25-100	30-100	35-100	40-100	50-100

mm

### TORNILLO HEXAGONAL ROSCA COMPLETA

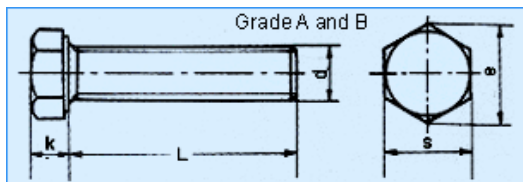
**ISO 4017**

GRADO DE RESISTENCIA
8.8
10.9
12.9

Rosca	M5	M6	M8	M10	M12	M16	M20	M24	M30	M36
Paso	0.8	1	1.25	1.5	1.75	2	2.5	3	3.5	4
k	3.5	4	5.3	6.4	7.5	10	12.5	15	18.7	22.5
e	Grado A	8.79	11.05	14.38	17.77	20.03	26.75	33.53	39.98	-
	Grado B	-	-	-	-	-	26.17	32.95	39.55	50.85
S	8	10	13	16	18	24	30	36	46	55
L	8-40	8-50	12-60	16-60	20-80	30-100	40-100	50-100	70-100	80-100

mm



**PERNO HEXAGONAL MEDIA ROSCA**

**DIN 931**

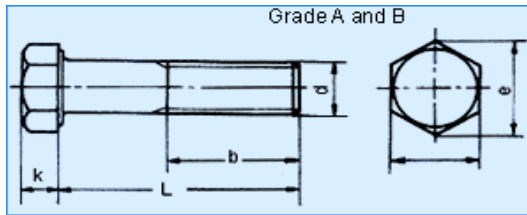

GRADO DE RESISTENCIA
8.8
10.9
12.9

mm

Rosca	M4	M5	M6	M8	M10	M12	M14	M16	M18	M20	M22	M24	M27	M30
Paso	0.7	0.8	1	1.25	1.5	1.75	2	2	2.5	2.5	2.5	3	3	3.5
b	125	14	16	18	22	26	30	34	38	42	46	50	54	60
	L ≥ 200	-	22	24	28	32	36	40	44	48	52	56	60	66
	200	-	-	-	-	45	49	53	57	61	65	69	73	79
k	2.8	3.5	4	5.3	6.4	7.5	8.8	10	11.5	12.5	14	15	17	18.7
e	A	7.66	8.79	11.05	14.38	18.9	21.1	24.49	26.75	30.14	33.53	35.72	39.98	45.2
	B	-	8.63	10.89	14.20	18.72	20.88	23.91	26.17	29.56	32.95	35.03	39.55	45.2
S	7	8	10	13	17	19	22	24	27	30	32	36	41	46
L	25-40	25-50	30-60	35-80	40-100	45-120	50-140	55-160	65-180	65-200	70-220	80-240	90-260	90-300

**PERNO HEXAGONAL MEDIA ROSCA**

**DIN 601**

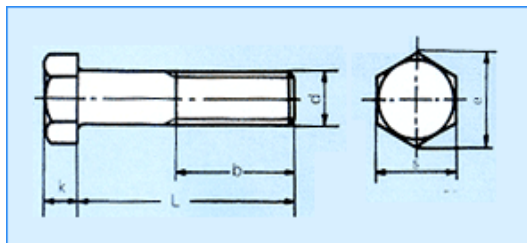

GRADO DE RESISTENCIA
4.8

mm

Rosca	M5	M6	M8	M10	M12	M16	M20	M24	M27	M30	M36
Paso	0.8	1	1.25	1.5	1.75	2	2.5	3	3	3.5	4
b	L ≤ 125	16	18	22	26	30	38	46	54	60	78
	125 < L ≤ 200	22	24	28	32	36	44	52	60	66	84
	L > 200	35	37	41	45	49	57	65	73	79	97
k	3.5	4	5.3	6.4	7.5	10	12.5	15	17	18.7	22.5
e	8.63	10.89	14.2	18.72	20.88	26.17	32.95	39.55	45.2	50.85	60.79
S	8	10	13	17	19	24	30	36	41	46	55
L	25-50	30-60	35-80	40-100	45-100	55-100	65-200	80-240	90-300	90-300	300

**PERNO HEXAGONAL MEDIA ROSCA**

**ISO 4014**

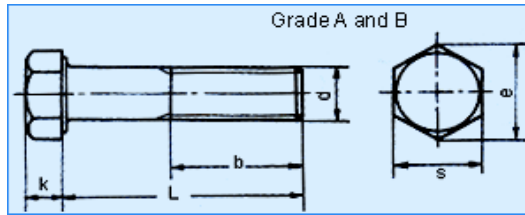

GRADO DE RESISTENCIA
8.8
10.9
12.9

		mm									
<b>Rosca</b>		M5	M6	M8	M10	M12	M16	M20	M24	M30	M36+
<b>Paso</b>		0.8	1	1.25	1.5	1.75	2	2.5	3	3.5	4
<b>b</b>	L ≤ 125	16	18	22	26	30	38	46	54	66	-
	125 < L ≤ 200	-	-	-	-	-	44	52	60	72	84
	L > 200	-	-	-	-	-	-	-	73	85	97
<b>k</b>		3.5	4	5.3	6.4	7.5	10	12.5	15	18.7	22.5
<b>e</b>	Grado A	8.79	11.05	14.38	17.77	20.03	26.75	33.53	39.98	-	-
	Grado B	-	-	-	-	-	26.17	32.95	39.56	50.85	60.79
<b>S</b>		8	10	13	16	18	24	30	36	46	55
<b>L</b>		25-50	30-60	35-80	40-100	45-120	55-160	65-200	80-240	90-300	300

**PERNOS DE CABEZA HEXAGONAL CON TUERCA**

**DIN 7990**

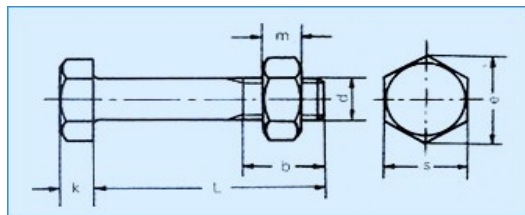

GRADO DE RESISTENCIA
10.9

		mm						
<b>d1</b>		M12	M16	M20	M22	M24	M27	M30
<b>d</b>		17.75	21	23.5	25.5	26	29	30.5
<b>e</b>		20.88	26.17	32.95	35.03	39.55	45.20	50.85
<b>k</b>		8	10	13	14	15	17	19
<b>m</b>		10	13	16	18	19	22	24
<b>s</b>		19	24	30	32	36	41	46
<b>L</b>		30-120	35-150	40-175	40-200	45-200	60-200	80-200

**PERNOS HEXAGONALES DE ALTA RESISTENCIA**

**DIN 6914**

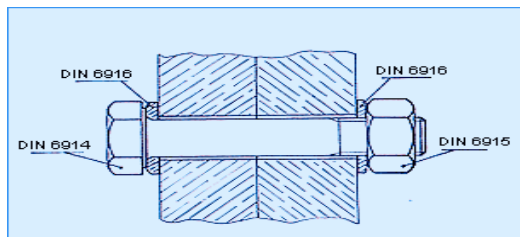

GRADO DE RESISTENCIA
10.9

		mm		
<b>DIN6914</b>	<b>Diametro d</b>	M12-M30	<b>Longitud L</b>	30-200
<b>Tuerca</b>	<b>Diametro D</b>	M12-M30	-	-
<b>Arandela</b>	<b>Diametro d</b>	M13-M31	-	-

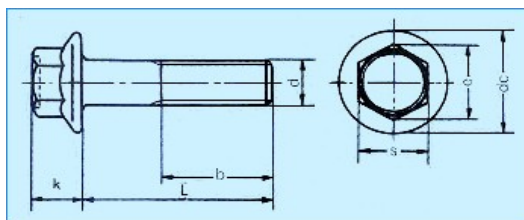
**TORNILLO HEXAGONAL CON COLLAR BISELADO**
**DIN 6921**

GRADO DE RESISTENCIA
4.8
8.8

mm

Rosca	M5	M6	M8	M10	M12	M14	M16	M20
Paso	0.8	1	1.25	1.5	1.75	2	2	2.5
b	L ≤ 125	16	18	22	26	30	34	46
	125 < L ≤ 200	-	-	28	32	36	40	52
	L > 200	-	-	-	-	-	-	57
dc	11.8	14.2	18	22.3	26.6	30.5	35	43
k	5.4	6.6	8.1	9.2	11.5	12.8	14.4	17.1
e	8.71	10.95	14.26	16.5	17.62	19.86	23.15	29.87
S	8	10	13	15	16	18	21	27
L	oct-50	dic-60	16-80	20-100	25-120	30-140	35-160	40-200

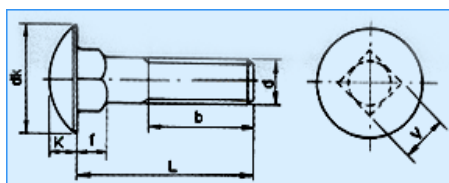
**TORNILLO CON CUELLO CUADRADO (CUADRADILLO)**
**DIN 603**

GRADO DE RESISTENCIA
4.8
8.8

mm

Rosca	M6	M8	M10	M12
Paso	1	1.25	1.5	1.75
b	L ≤ 125	18	22	30
	125 < L ≤ 200	24	28	36
	L > 200	-	41	49
dk	16.55	20.65	24.65	30.65
f	4.6	5.6	6.6	8.75
k	3.88	4.88	5.38	6.95
v	6.48	8.58	1.58	12.7
L	16-80	20-100	20-100	30-100

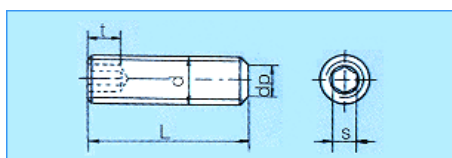
**ESPÁRRAGO ROSCADO HEXAGONAL CON PUNTA PLANA**
**DIN 913**

mm

Rosca	M3	M4	M5	M6	M8	M10	M12	M16	M20
dp	2	2.5	3.5	4	5.5	7	8.5	12	15
s	1.5	2	2.5	3	4	5	6	8	10
t	1.2	1.5	2	2	3	4	4.8	6.4	8
L	4-16	5-20	6-25	8-30	10-40	12-50	16-60	20-60	25-60

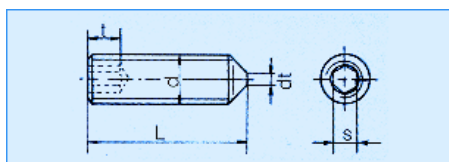
**ESPÁRRAGO ROSCADO HEXAGONAL CON PUNTA CÓNICA**
**DIN 914**

Rosca	M3	M4	M5	M6	M8	M10	M12	M16	M20
dt	-	-	-	1.5	2	2.5	3	4	5
s	1.5	2	2.5	3	4	5	6	8	10
t	1.2	1.5	2	2	3	4	4.8	6.4	8
L	5-16	6-20	8-25	10-30	12-40	16-50	20-60	25-60	30-60

mm

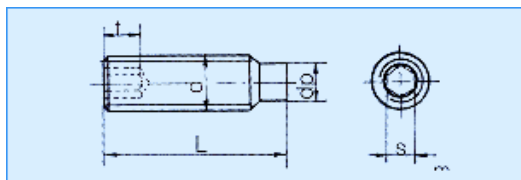
**ESPÁRRAGO ROSCADO HEXAGONAL CON PUNTA DE PIVOTE**
**DIN 915**

Rosca	M3	M4	M5	M6	M8	M10	M12	M16	M20
dp	2	2.5	3.5	4	5.5	7	8.5	12	15
s	1.5	2	2.5	3	4	5	6	8	10
t	1.2	1.5	2	2	3	4	4.8	6.4	8
z	Corto	0.75	1	1.25	1.5	2	2.5	3	4
	Largo	1.5	2	2.5	3	4	5	6	8
L	6-16	8-20	10-25	14-30	16-40	20-50	25-60	30-60	35-60

mm

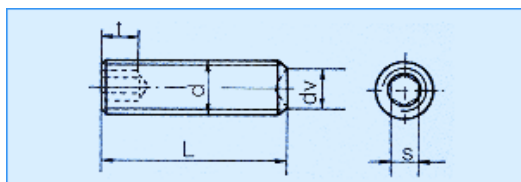
**ESPÁRRAGO ROSCADO HEXAGONAL CON PUNTA CON CONO INTERNO**
**DIN 916**

Rosca	M3	M4	M5	M6	M8	M10	M12	M16	M20
dv	1.4	2	2.5	3	5	6	8	10	14
s	1.5	2	2.5	3	4	5	6	8	10
t	1.2	1.5	2	2	3	4	4.8	6.4	8
L	4-16	5-20	6-25	8-30	10-40	12-50	16-60	20-60	25-60

mm

## TORNILLOS ALLEN

DIN 912

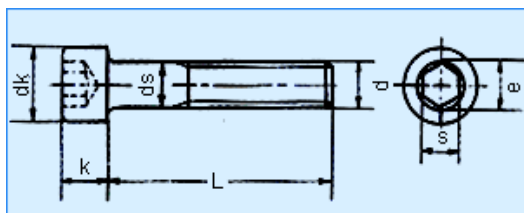

GRADO DE RESISTENCIA
8.8
10.9
12.9

mm

Roscas	M3	M4	M5	M6	M8	M10	M12	M14	M16	M20
Paso	0.5	0.7	0.8	1	1.25	1.5	1.75	2	2	2.5
dk	5.32	6.78	8.28	9.78	12.73	15.73	17.73	20.67	23.67	29.67
ds	3	4	5	6	8	10	12	14	16	20
k	2.86	3.82	4.82	5.7	7.64	9.64	11.57	13.57	15.57	19.48
e	2.87	3.44	4.58	5.72	6.86	9.15	11.43	13.72	16	19.44
s	2.5	3	4	5	6	8	10	12	14	17
L	5-30	6-40	8-50	10-60	12-80	16-100	20-120	25-140	25-160	30-200

## TORNILLO ALLEN AVELLANADO

DIN 7991

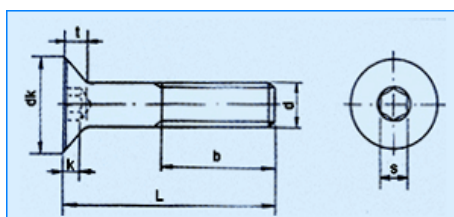

mm

Rosca	M3	M4	M5	M6	M8	M10	M12	M16	M20	
b	L < 125	12	14	16	18	22	26	30	38	46
	125 < L ≤ 200				24	28	32	36	44	52
	L > 200						45	49	57	65
dk	6	8	10	12	16	20	24	30	36	
k	1.70	2.30	2.80	3.30	4.40	5.50	6.50	7.50	8.50	
s	2.00	2.50	3.00	4.00	5.00	6.00	8.00	10.0	12.0	
t	0.95	1.55	2.05	2.25	3.20	4.10	4.30	5.00	5.60	
L	8-30	8-40	10-50	12-50	16-60	20-70	25-70	35-90	40-100	

## TENSORES

DIN 1480

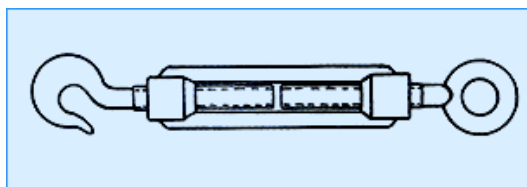

mm

DIMENSIONES DISPONIBLES										
Rosca	6X10	8X110	10X12	12X12	14X14	16X17	20X20	22X22	24X25	30X25



**TORNILLOS CON ANILLA (CÁNCAMOS)**

**DIN 580**

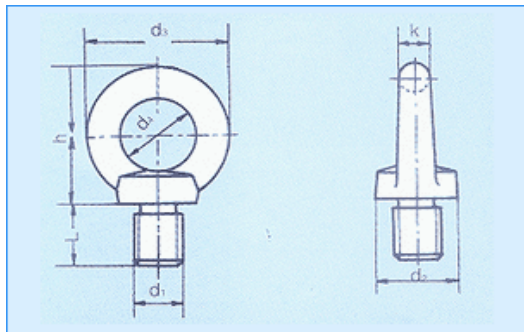

mm

d1	M8	M10	M12	M16	M20	M24	M30	M36
d2	20	25	30	35	40	50	65	75
d3	36	45	54	63	72	90	108	128
d4	20	25	30	35	40	50	60	70
h	36	45	53	62	71	90	109	128
k	8	10	12	14	16	20	24	28
L	13	17	20.5	27	30	36	45	54

**TORNILLO CON OJO**

**DIN 444**

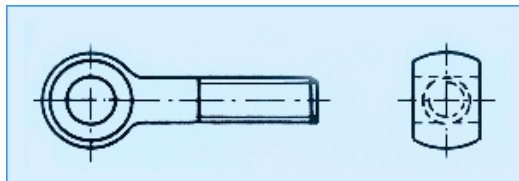

mm

Rosca	M5	M6	M8	M10	M12	M16	M20	M24	M30
Longitud	30-50	30-60	40-80	50-100	60-120	60-150	65-200	80-200	90-300

**PERNOS DE ANCLAJE**

**DIN 529**



mm

Rosca	M8	M10	M12	M16	M20	M24	M30
Longitud	80-125	111-160	180	200	250	320	400



## PERNOS PARA SOLDAR

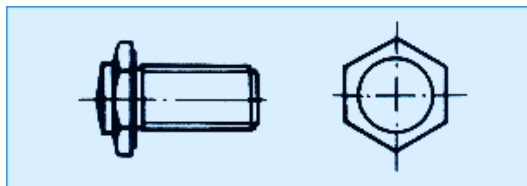

Tamaño de rosca **M8×19**

## PERNOS DE TRACCIÓN



Dimensiones **1/4-20 × 3-1/2** **1/4-20 × 4**

## TORNILLO DE MARIPOSA

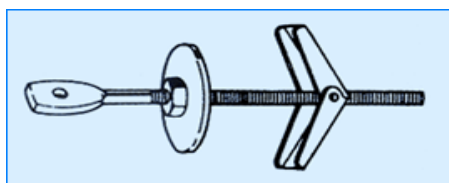

Dimensiones **1/4-20 × 4-1/4**

## TUERCAS

### TUERCAS HEXAGONALES

**DIN 555**

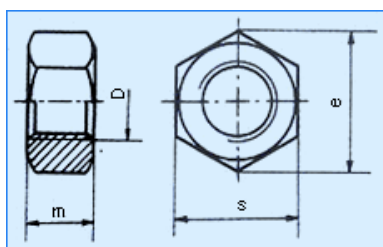

mm

Rosca	M5	M6	M8	M10	M12	M16	M20	M24	M30	M36	M42	M48	M56
Paso	0.8	1	1.25	1.5	1.75	2	2.5	3	3.5	4	4.5	5	5.5
m	4	5	6.5	8	10	13	16	19	24	29	34	38	45
e	8.63	10.89	14.2	18.72	20.88	26.17	32.95	39.55	50.85	60.79	71.3	82.6	93.56
s	8	10	13	17	19	24	30	36	46	55	65	75	85

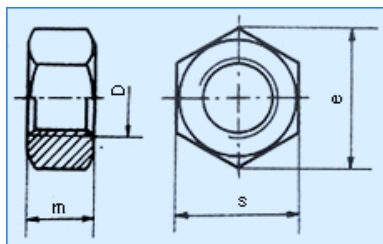
**TUERCAS HEXAGONALES**
**DIN 934**

mm

<b>Rosca</b>	<b>M2</b>	<b>M3</b>	<b>M4</b>	<b>M5</b>	<b>M6</b>	<b>M8</b>	<b>M10</b>	<b>M12</b>	<b>M16</b>
<b>Paso</b>	0.4	0.5	0.7	0.8	1	1.25	1.5	1.75	2
<b>m</b>	1.6	2.4	3.2	4	5	6.5	8	10	13
<b>e</b>	4.32	6.01	7.66	8.79	11.05	14.38	18.9	21.1	16.75
<b>s</b>	4	5.5	7	8	10	13	17	19	24
<b>Rosca</b>	<b>M20</b>	<b>M24</b>	<b>M30</b>	<b>M36</b>	<b>M42</b>	<b>M48</b>	<b>M56</b>		
<b>Paso</b>	2.5	3	3.5	4	4.5	5	5.5		
<b>m</b>	16	19	24	29	34	38	45		
<b>e</b>	32.95	39.55	50.85	60.79	71.3	82.6	93.56		
<b>s</b>	30	36	46	55	65	75	85		

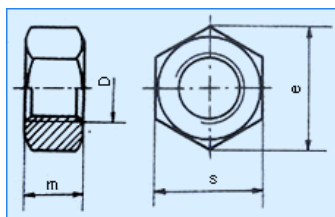
**TUERCAS HEXAGONALES BRILLANTES**
**B.S. 1083**

inches

<b>Rosca</b>	<b>1/8</b>	<b>5/32</b>	<b>3/16</b>	<b>1/4</b>	<b>5/16</b>	<b>3/8</b>	<b>7/16</b>	<b>1/2</b>
<b>Paso</b>	40	32	24	20	18	16	14	12
<b>s</b>	5.59	7.6	8.23	11.30	13.34	15.24	18.03	20.83
<b>e</b>	6.40	8.20	9.50	13.00	15.30	17.50	20.70	24.10
<b>m</b>	3.04	3.88	4.24	5.08	6.35	7.92	9.53	11.10

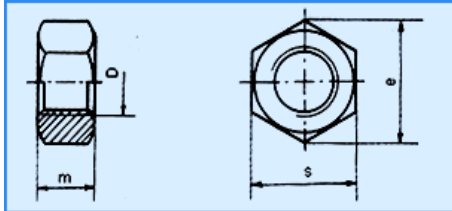
**TRUERCAS HEXAGONALES**
**AS 1112**

mm

<b>Rosca</b>	<b>M2</b>	<b>M3</b>	<b>M4</b>	<b>M5</b>	<b>M6</b>	<b>M8</b>	<b>M10</b>	<b>M12</b>	<b>M16</b>
<b>Paso</b>	0.4	0.5	0.7	0.8	1.0	1.25	1.5	1.75	2.0
<b>s</b>	1.6	2.4	3.2	4.7	5.2	6.8	8.4	10.8	14.8
<b>e</b>	4.32	6.01	7.66	8.79	11.05	14.38	17.77	20.03	26.75
<b>s</b>	4	5.5	7	8	10	13	16	18	24
<b>Rosca</b>	<b>M20</b>	<b>M24</b>	<b>M30</b>	<b>M36</b>	<b>M42</b>	<b>M48</b>	<b>M56</b>		
<b>Paso</b>	2.5	3.0	3.5	4.0	4.5	5.0	5.5		
<b>s</b>	18	21.5	25.6	31	34.8	38.8	45.8		
<b>e</b>	32.95	39.55	50.85	60.79	71.30	82.60	93.50		
<b>s</b>	30	36	46	55	65	75	85		

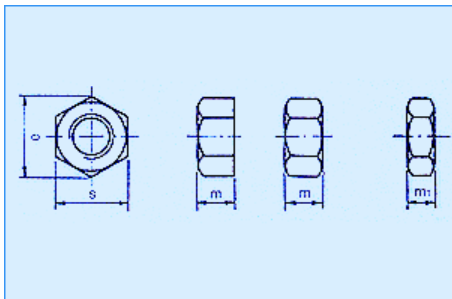
**TUERCAS HEXAGONALES**
**B.S. 1768**

inches

<b>Rosca</b>	<b>1/4</b>	<b>5/16</b>	<b>3/8</b>	<b>7/16</b>	<b>1/2</b>	<b>9/16</b>	<b>5/8</b>	<b>3/4</b>	<b>7/8</b>
<b>e</b>	0.505	0.577	0.650	0.794	0.866	1.010	1.083	1.300	1.515
<b>s</b>	0.437	0.500	0.562	0.687	0.750	0.875	0.937	1.125	1.312
<b>m</b>	0.224	0.271	0.333	0.380	0.442	0.489	0.552	0.651	0.760
<b>m1</b>	0.286	0.333	0.411	0.458	0.567	0.614	0.724	0.822	0.916
<b>m2</b>	0.161	0.192	0.224	0.255	0.317	0.349	0.380	0.432	0.494
<b>Rosca</b>	<b>1</b>	<b>1 1/8</b>	<b>1 1/4</b>	<b>1 3/8</b>	<b>1 1/2</b>	<b>1 3/4</b>	<b>2</b>		
<b>e</b>	1.732	1.948	2.165	2.382	2.598	3.031	3.461		
<b>s</b>	1.500	1.687	1.875	2.062	2.250	2.625	3.000		
<b>m</b>	0.874	0.989	1.087	1.197	1.311	1.530	1.754		
<b>m1</b>	1.015	1.176	1.275	1.400	1.530	-	-		
<b>m2</b>	0.562	0.629	0.744	0.806	0.874	0.999	1.129		

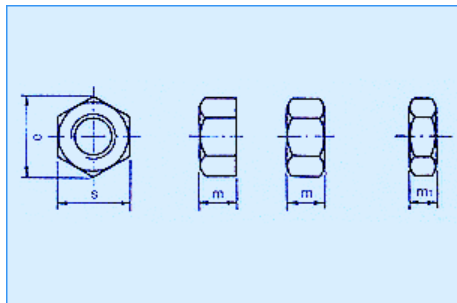
**TUERCAS HEXAGONALES**
**B.S. 1769**

inches

Rosca	1/2	5/8	3/4	7/8	1	1 1/8	1 1/4	1 3/8	1 1/2	1 3/4	2
P UNC	13	11	10	9	8	7	7	6	6	5	4 1/2
P UNF	20	18	16	14	12	12	12	12	12	-	-
e	1.01	1.23	1.44	1.66	1.88	2.09	2.31	2.53	2.74	3.18	3.61
s	0.875	1.062	1.250	1.437	1.625	1.812	2.000	2.187	2.375	2.750	3.125
m	0.520	0.647	0.774	0.901	1.028	1.155	1.282	1.409	1.536	1.790	2.044
m1	0.332	0.397	0.462	0.526	0.590	0.655	0.782	0.846	0.911	1.040	1.169

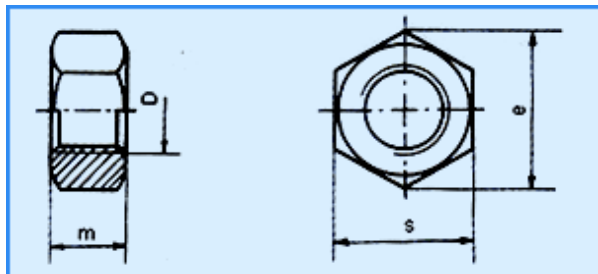
**TUERCAS HEXAGONALES**
**ISO 4032**

mm

Rosca	M2	M3	M4	M5	M6	M8	M10	M12	M16
Paso	0.4	0.5	0.7	0.8	1	1.25	1.5	1.75	2
m	1.6	2.4	3.2	4.7	5.2	6.8	8.4	10.8	14.8
e	4.32	6.01	7.66	8.79	11.05	14.38	17.77	20.03	26.75
s	4	5.5	7	8	10	13	16	18	24
Rosca	M20	M24	M30	M36	M42	M48	M56		
Paso	2.5	3	3.5	4	4.5	5	5.5		
m	18	21.5	25.6	31	34	38	45		
e	32.95	39.55	50.85	60.79	71.3	82.6	93.56		
s	30	36	46	55	65	75	85		

**TUERCAS HEXAGONALES**

**ISO 4033**

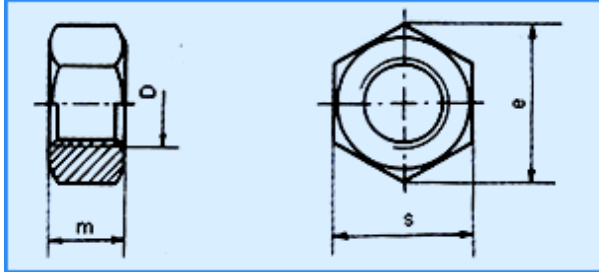

Rosca	M5	M6	M8	M10	M12	M16	M20	M24	M30	M36
Paso	0.8	1	1.25	1.5	1.75	2	2.5	3	3.5	4
m	5.1	5.7	7.5	9.3	12	16.4	20.3	23.9	28.6	34.7
e	8.79	11.05	14.38	17.77	20.03	26.75	32.95	39.55	50.85	60.79
s	8	10	13	16	18	24	30	36	46	55

mm

**TUERCAS HEXAGONALES**

**ISO 4034**

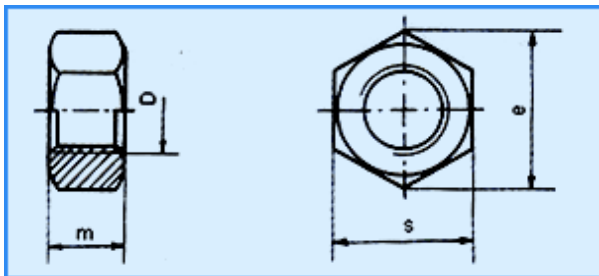

Rosca	M5	M6	M8	M10	M12	M16	M20	M24	M30	M36
Paso	0.8	1	1.25	1.5	1.75	2	2.5	3	3.5	4
m	5.6	6.1	7.9	9.5	12.2	15.9	19	22.3	26.4	31.5
e	8.63	10.89	14.20	17.59	19.85	26.17	32.95	39.55	50.85	60.79
s	8	10	13	16	18	24	30	35	45	53.8

mm

**TUERCA HEXAGONAL DELGADA**

**ISO 4035**

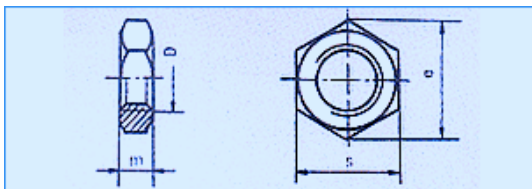

Rosca	M10	M12	M14	M22
Paso	1.5	1.75	2	2.5
m	5	6	7	11
e	17.77	20.03	23.35	37.29
s	16	18	21	24

mm

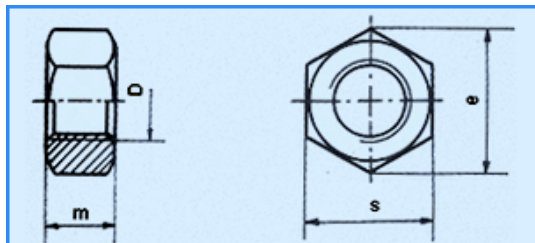
**TUERCAS HEXAGONALES**
**UNI 5587**

Rosca	M3	M4	M5	M6	M8	M10	M12	M16	M20	M24	M30
m	3	4	5	6	8	10	12	16	20	24	30
e	6.08	7.74	8.87	11.05	14.38	18.90	21.10	26.75	33.53	39.98	51.29
s	5.5	7	8	10	13	17	19	24	30	36	46

mm

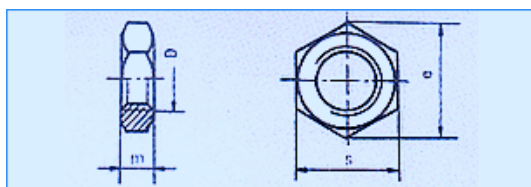
**TUERCAS HEXAGONALES DELGADAS ACHAFLANADAS**
**DIN 439**

Rosca	M3	M4	M5	M6	M8	M10	M12	M16	M20	M24	M30	M36	M42	M48
Paso	0.5	0.7	0.8	1	1.25	1.5	1.75	2	2.5	3	3.5	4	4.5	5
m	1.8	2.2	2.7	3.2	4	5	6	8	10	12	15	18	21	24
e	6.01	7.66	8.79	11.05	14.38	18.9	21.1	26.75	32.95	39.55	50.85	60.79	71.3	82.6
s	5.5	7	8	10	13	17	19	24	30	36	46	55	65	75

mm

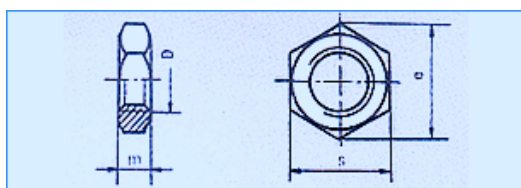
**TUERCAS HEXAGONALES DELGADAS**
**DIN 936**

Rosca	M8	M10	M12	M16	M20	M24	M30	M36	M42	M48
Paso	1.25	1.5	1.75	2	2.5	3	3.5	4	4.5	5
m	5	6	7	8	9	10	12	14	16	18
e	14.38	18.90	21.1	26.75	32.95	39.55	50.85	60.79	71.3	82.6
s	13	17	19	24	30	36	46	55	65	75

mm



**TUERCA AUTOBLOCANTE METÁLICA**

**DIN 980**

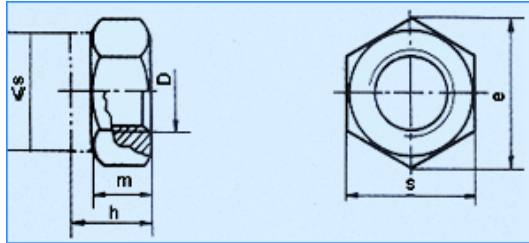

mm

Rosca	M5	M6	M8	M10	M12	M14	M16	M18	M20
Paso	0.8	1	1.25	1.5	1.75	2	2	2.5	2.5
h	5.1	6	8	10	12	14	16	18	20
e	8.79	11.05	14.38	18.9	21.1	24.49	26.75	29.56	32.95
s	8	10	13	17	19	22	24	27	30

**TUERCA AUTOBLOCANTE CON INSERCIÓN NO METÁLICA**

**DIN 985**

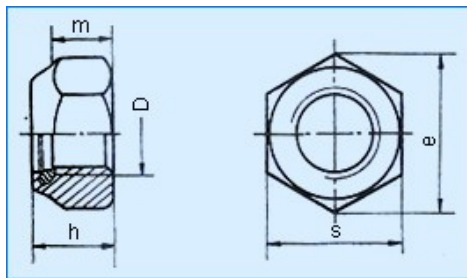

mm

Rosca	M5	M6	M8	M10	M12	M14	M16	M18	M20
Paso	0.8	1	1.25	1.5	1.75	2	2	2.5	2.5
h	5	6	8	10	12	14	16	18.5	20
m	3.2	4	5.5	6.5	8	9.5	10.5	13	14
e	8.79	11.05	14.38	18.9	21.1	24.49	26.75	29.56	32.95
s	8	10	13	17	19	22	24	27	30

**TUERCA LARGA**

**DIN 6334**



Rosca	M6	M8	M10	M12	M16
-------	----	----	-----	-----	-----





## TUERCA PARA SOLDAR HEXAGONAL

DIN 929

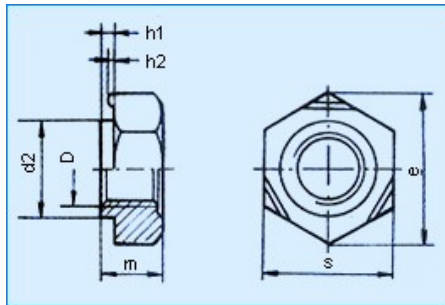

mm

Rosca	M4	M5	M6	M8	M10	M12	M16
m	3.5	4	5	6.5	8	10	13
e	9.83	10.95	12.02	15.38	18.74	20.91	26.51
s	9	10	11	14	17	19	24
h <sub>1</sub>	0.65	0.7	0.75	0.9	1.15	1.4	1.8
h <sub>2</sub>	0.35	0.4	0.4	0.5	0.65	0.8	1
d <sub>2</sub>	6	7	8	10.5	12.5	14.8	18.8

## TUERCA HEXAGONAL CONCOLLAR BISELADO

DIN 6923

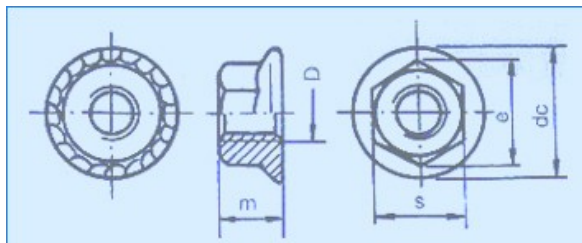

mm

Rosca	M5	M6	M8	M10	M12	M14	M16	M20
Paso	0.8	1	1.25	1.5	1.75	2	2	2.5
m	5	6	8	10	12	14	16	20
e	8.79	11.05	14.38	16.64	20.03	23.36	26.75	32.95
s	8	10	13	15	18	21	24	30
dc	11.8	14.2	17.9	21.8	26	29.9	34.5	42.8

**TUERCA ALMENADA HEXAGONAL**

**DIN 935**

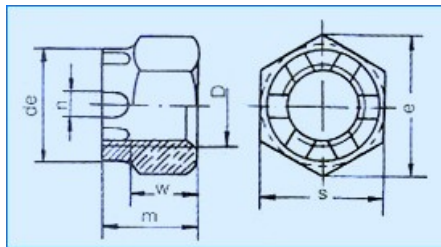

mm

Rosca	M6	M8	M10	M12	M16	M20	M24	M30	M36
m	7.5	9.5	12	15	19	22	27	33	38
e	11.05	14.38	17.77	20.03	26.75	32.95	39.55	50.85	60.79
s	10	13	16	18	24	30	36	46	55
n	2	2.5	2.8	3.5	4.5	4.5	5.5	7	7
w	5	6.5	8	10	13	16	19	24	29
de	-	-	-	16	22	28	34	42	50

**TUERCA ALMENADA HEXAGONAL**

**DIN 937**

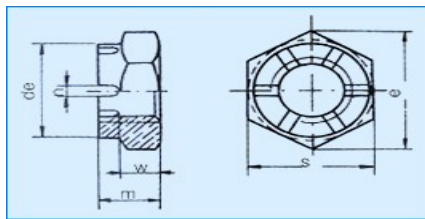

mm

Rosca	M6	M8	M10	M12	M16	M20	M24	M30	M36
m	6	8	9	10	12	13	15	18	20
e	11.05	14.38	18.9	20.1	26.75	32.95	35.55	50.85	60.79
s	10	13	17	19	24	30	36	46	55
n	2	2.5	2.8	3.5	4.5	4.5	5.5	7	7
w	3.5	4.5	5	6	7	8	9	11	13
de	-	-	-	17	22	28	33	41	49

**TUERCA ALMENADA HEXAGONAL DELGADA**

**DIN 979**

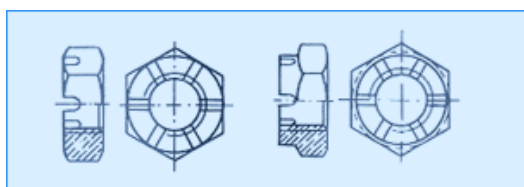

mm

Rosca	M6	M8	M10	M12	M16	M20	M24	M30	M36
m	5	6.5	8	10	13	16	19	24	29
e	11.05	14.38	17.77	20.03	26.75	32.95	39.55	50.85	60.79
s	10	13	16	18	24	30	36	46	55
n	2	2.5	2.8	3.5	4.5	4.5	5.5	7	7
w	2.5	3.5	4	5	7	10	11	15	20
de	-	-	-	16	22	28	34	42	50

**TUERCA CIEGA BAJA**

**DIN 917**

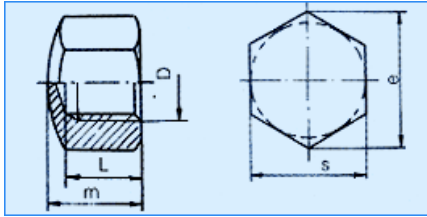

mm

Rosca	M4	M5	M6	M8	M10	M12	M16	M20	M24
m	5.5	7	9	12	14	16	20	25	30
e	7.66	8.79	11.05	14.38	17.77	20.03	26.75	32.95	39.55
s	7	8	10	13	16	18	24	30	36
L	4.16	4.96	6.71	9.21	10.65	13.15	16.65	20.58	23.58

**TUERCA CIEGA AUTOBLOCANTE**

**DIN 986**

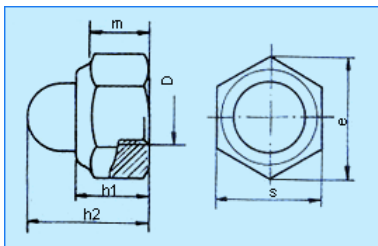

mm

Rosca	M4	M5	M6	M8	M10	M12	M16	M20
m	2.9	4.4	4.9	6.44	8.04	10.37	14.1	16.9
e	7.66	8.79	11.05	14.38	18.9	21.1	26.75	32.95
s	7	8	10	13	16	18	24	30
h <sub>1</sub>	5.6	6	7.5	8.9	10.5	13.5	16.5	21
h <sub>2</sub>	9.6	10.5	12	14	18.1	22.5	27.5	35

**TUERCA CIEGA**

**DIN 1587**

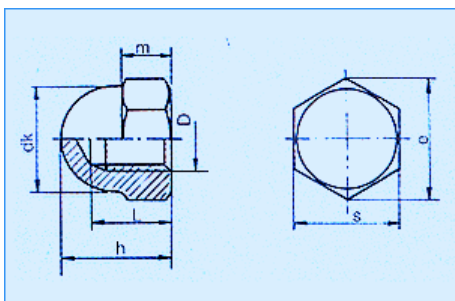

mm

Rosca	M4	M5	M6	M8	M10	M12	M16	M20	M24
m	3.2	4	5	6.5	8	10	13	16	19
e	7.66	8.79	11.05	14.38	17.77	20.03	26.75	33.53	39.98
s	7	8	10	13	16	18	24	30	36
h	8	10	12	15	18	22	28	34	42
L	5.26	7.21	7.71	10.65	12.65	15.65	20.58	25.58	30.5
dk	6.5	7.5	9.5	12.5	15	17	23	28	34

## TUERCA MARIPOSA

**DIN 315**

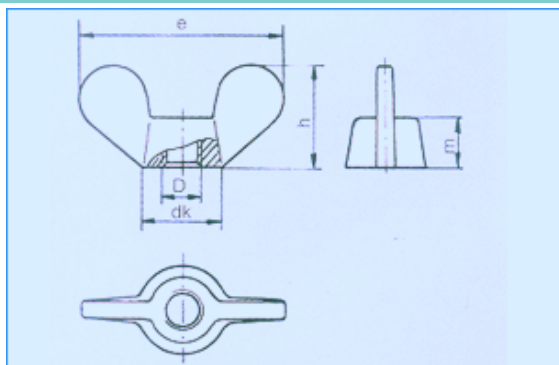

mm

Rosca	M4	M5	M6	M8	M10	M12	M16	M20	M24
Paso	0.7	0.8	1	1.25	1.15	1.75	2	2.5	3
dk	6	8	10	13	17	20	26	32	41
e	18	24	30	36	48	62	70	86	106
h	8.5	11	15	18	23	31	35	44	53.5
m	3.2	4	5	6.5	8	10	13	16	20

## TUERCA CUADRADA PLANA

**DIN 562**

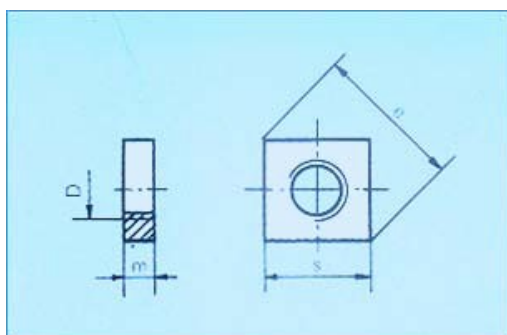

mm

Rosca	M2	M3	M4	M5	M6	M8	M10	
Paso	0.4	0.5	0.7	0.8	1	1.25	1.5	
m	1.2	1.8	2.2	2.7	3.2	4	5	
e	5	7	8.9	10.2	12.7	16.5	20.2	21.5
S	4	5.5	7	8	10	13	16	17

## TUERCA PARA SOLDAR CUADRADA

**DIN 928**

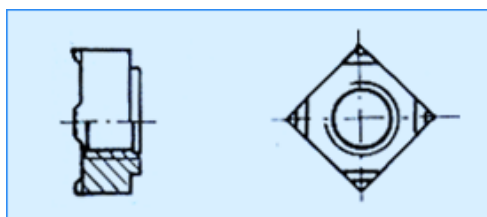

mm

Rosca	M4	M5	M6	M8	M10	M12
-------	----	----	----	----	-----	-----

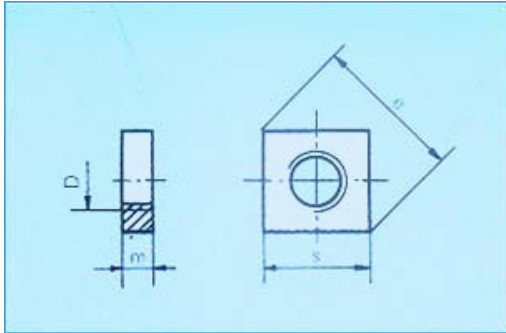
**TUERCAS CUADRADAS**
**B.S.**

	inches			
Rosca	1/8	5/32	3/16	1/4
Roscas por pulgada	40	32	24	20
m	2.13	2.74	3.12	3.38
e	7.9	10.1	11.6	15.9
s	5.59	7.16	8.23	11.30

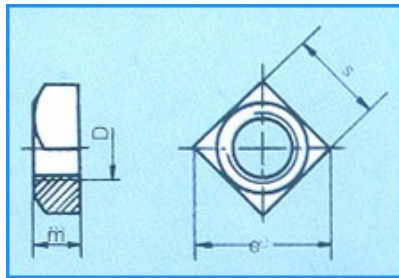

	inches					
Rosca	3/16	1/4	5/16	3/8	7/16	1/2
Roscas por pulgada	24	20	18	16	14	12
m	4.24	5.08	6.35	7.92	9.53	11.10
e	11.6	15.9	18.9	21.5	25.4	29.4
s	8.23	11.3	13.34	15.24	18.03	20.83

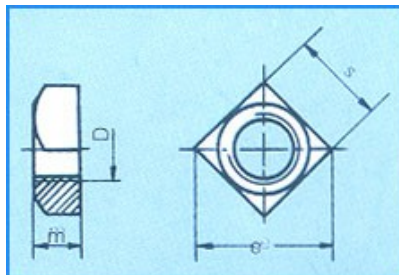
**TUERCAS CUADRADAS**
**DIN 557**

	mm								
Rosca	M5	M6	M8	M10	M12	M16	M20		
Paso	0.8	1	1.25	1.5	1.75	2	2.5		
m	4	5	6.5	8	10	13	16		
e	11.3	14.1	18.4	22.6	24	25.4	26.9	32.9	42.4
s	8	10	13	16	17	18	19	24	30



## TUERCAS T

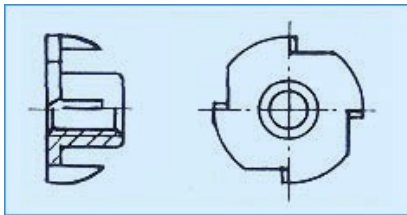

Rosca	M3	M4	M5	M6	M8	M10
-------	----	----	----	----	----	-----

## TUERCA DE SEGURIDAD

DIN 7967



Roscas	M3	M4	M5	M6	M8	M10	M12	M14	M16	M18
	M20	M22	M24	M27	M30	M33	M36	M39	M42	

## TUERCA DE ANILLA

DIN 582

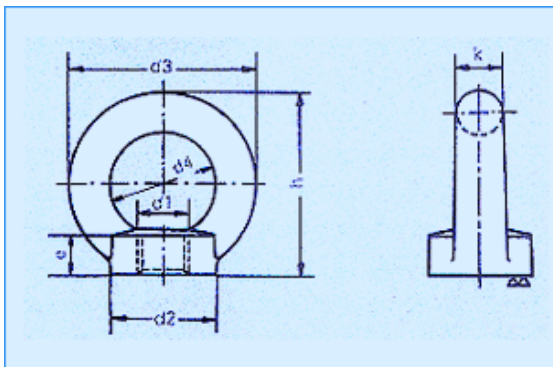

	mm							
d1	M8	M10	M12	M16	M20	M24	M30	M36
d2	20	25	30	35	40	50	65	75
d3	36	45	54	63	72	90	108	126
d4	20	25	30	35	40	50	60	70
e	8.5	10	11	13	16	20	25	30
h	36	45	53	62	71	90	109	128
k	8	10	12	14	16	20	24	28

## EYE COUPLING NUTS

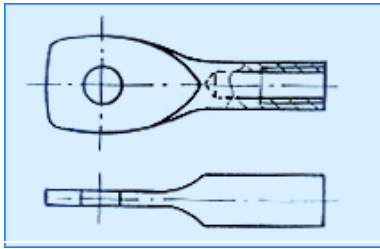

Rosca	M6
-------	----

## TUERCAS DE ANCLAJE

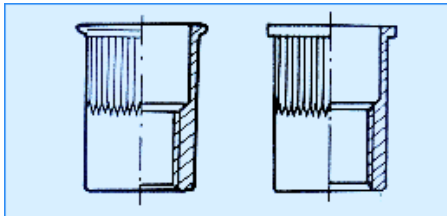

Rosca	M3	M4	M5	M6	M8	M10
-------	----	----	----	----	----	-----

## ARANDELAS

### ARANDELAS (GRADO A)

DIN 125

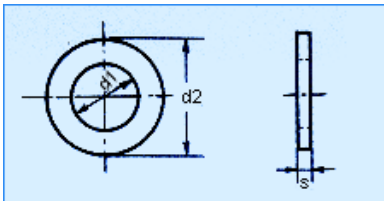

	mm										
d1	1.7	1.8	2.2	2.5	2.7	2.8	3.2	3.7	4.3	5.3	6.4
d2	4	4.5	5	6	6	7	7	8	9	10	12
s	0.3	0.3	0.3	0.5	0.5	0.5	0.5	0.5	0.8	1	1.6
d1	7.4	8.4	10.5	13	15	17	19	21	23	23	
d2	14	16	20	24	28	30	34	37	39	39	
s	1.6	1.6	2	2.5	2.5	3	3	3	3	3	



**ARANDELAS (GRADO C) DIN 126**

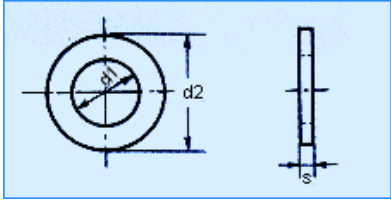

	mm										
d1	5.5	6.6	7.6	9	11	13.5	15.5	17.5	20	22	24
d2	10	12.5	14	16	20	24	28	30	34	37	39
s	1	1.6	1.6	1.6	2	2.5	2.5	3	3	3	3
d1	26	30	33	36	39	42	45	48	52	56	
d2	44	50	56	60	66	72	78	85	92	98	
s	4	4	4	5	5	6	7	7	8	8	

**ARANDELA CUADRADA EN CUÑA (8%) DIN 434**

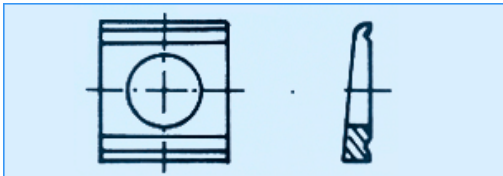

Para tornillos:	M8	M10	M12	M16	M20	M22	M24	M27
-----------------	----	-----	-----	-----	-----	-----	-----	-----

**ARANDELA CUADRADA EN CUÑA (14%) DIN 435**

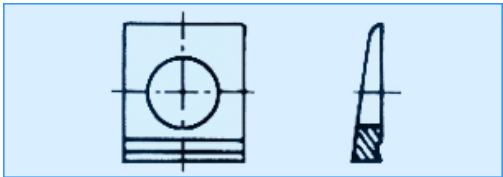

Para tornillos:	M8	M10	M12	M16	M20	M22	M24	M27	M30
-----------------	----	-----	-----	-----	-----	-----	-----	-----	-----

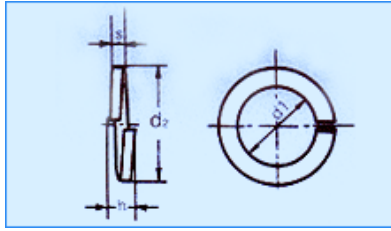
**ARANDELA GROWER**
**DIN 127**

Dimensión nominal	3	3.5	4	5	6	7	8	10	12
d1	3.4	3.9	4.4	5.4	6.5	7.5	8.5	10.7	12.7
d2	6.2	6.7	7.6	9.2	11.8	12.8	14.8	18.1	21.1
h	1.9	1.9	2.1	2.8	3.8	3.8	4.7	5.2	5.9
s	0.8	0.8	0.9	1.2	1.6	1.6	2	2.2	2.5
Dimensión nominal	14	16	18	20	22	24	27	30	
d1	14.7	17	19	21.2	23.5	25.5	28.5	31.7	
d2	24.1	27.4	29.4	33.6	35.9	40	43	48.2	
h	7.1	8.3	8.3	9.4	9.4	11.8	11.8	14.2	
s	3	3.5	3.5	4	4	5	5	6	

mm

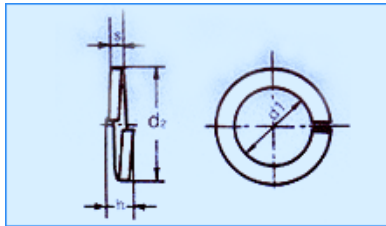
**ARANDELA GROWER**
**B.S.**

Dimensión nominal	1/8	5/32	3/16	1/4	5/16	3/8	7/16	1/2	9/16
d1	0.133	0.164	0.196	0.266	0.328	0.391	0.453	0.516	0.601
b	0.053	0.061	0.075	0.108	0.130	0.142	0.161	0.173	0.189
h	0.067	0.083	0.098	0.142	0.165	0.189	0.220	0.244	0.283
s	0.033	0.041	0.049	0.071	0.083	0.094	0.110	0.122	0.142
Dimensión nominal	5/8	3/4	7/8	1	1 1/8	1 1/4	1 1/2		
d1	0.656	0.781	0.906	1.031	1.156	1.281	1.531		
b	0.213	0.248	0.276	0.291	0.307	0.331	0.354		
h	0.303	0.354	0.394	0.433	0.472	0.504	0.551		
s	0.152	0.177	0.197	0.217	0.236	0.252	0.276		

inches

## TORNILLOS PARA METAL

### TORNILLO DE CABEZA CILÍNDRICA RANURADA

**DIN 84**

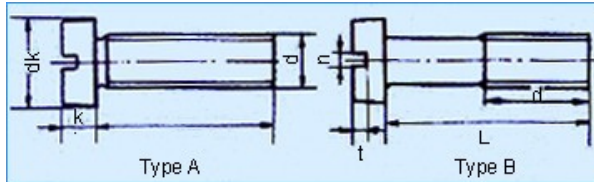

		mm						
Rosca		M3	M3.5	M4	M5	M6	M8	M10
dk		5.5	6	7	8.5	10	13	16
k		2	2.4	2.6	3.3	3.9	5	6
L	A	6-22	6-22	8-25	8-28	10-35	14-40	18-45
	B	25-30	25-35	28-40	30-50	40-60	45-80	50-100

### TORNILLO DE CABEZA ALOMADA RANURADA

**DIN 85**

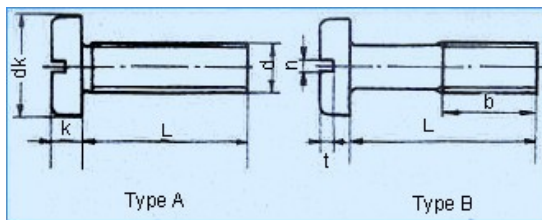

		mm						
Rosca		M3	M3.5	M4	M5	M6	M8	M10
dk		6	7	8	10	12	16	20
k		1.8	2.1	2.4	3	3.6	4.8	6
L	A	6-22	6-22	8-25	8-28	10-35	14-40	18-45
	B	25-30	25-35	28-40	30-50	40-60	45-80	50-100

### TORNILLO CABEZA PLANA AVELLANADO RANURADO

**DIN 963**

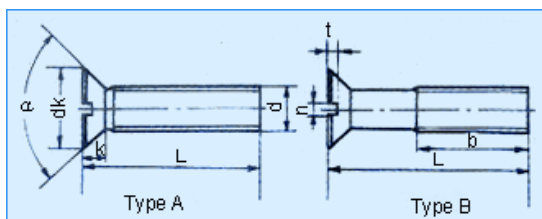

		mm						
Rosca		M3	M3.5	M4	M5	M6	M8	M10
dk		5.6	6.5	7.5	9.2	11	14.5	18
k		1.65	1.93	2.2	2.5	3	4	5
L	A	6-22	6-22	8-25	8-28	10-35	14-40	18-45
	B	25-30	25-35	28-40	30-50	40-60	45-80	50-100

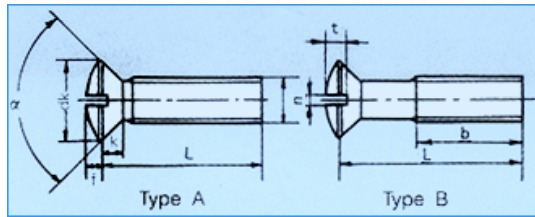
**TORNILLO CABEZA PLANA ALOMADA RANURADA**
**DIN 964**

mm

Rosca	M3	M3.5	M4	M5	M6	M8	M10
dk	5.6	6.5	7.5	9.2	11	14.5	18
k	1.65	1.93	2.2	2.5	3	4	5
f	0.75	0.9	1	1.25	1.5	2	2.5
L	A	6-22	6-22	8-25	8-28	10-35	14-40
	B	25-30	25-35	28-40	30-50	40-60	45-80

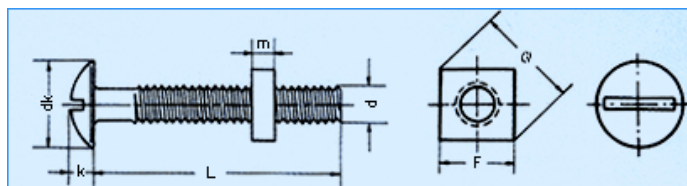
**TORNILLOS Y TUERCAS GALVANIZADOS PARA CUBIERTAS**

inches

Rosca	dk	k	m	F	G	L
3/6	10	2.3	3.048	8.128	11.684	3/16-3
1/4	13.3	3	0.302	11.176	16.002	1/2-5

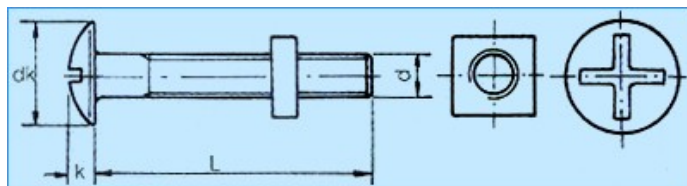
**TORNILLOS Y TUERCAS PARA CUBIERTAS**

mm

Rosca	M4	M5	M6	M8
dk	9.4	11.6	13.95	18.9
k	1.90	2.65	3.33	3.80
L	10-50	10-80	12-120	16-150

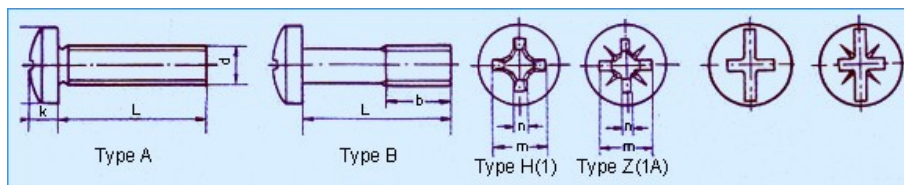
**TORNILLO DE CABEZA ALOMADA**
**DIN 7985**

		mm						
Rosca		M3	M3.5	M4	M5	M6	M8	M10
dk		6	7	8	10	12	16	20
k		2.4	2.7	3.1	3.8	4.6	6	7.5
Cruz	(Tipo H)m	3.1	4.2	4.6	5.3	6.8	9	10.2
	(Tipo Z)m	3	4	4.3	5	6.7	8.8	9.9
	No	1	2	2	2	3	4	4
L	Tipo A	6-22	6-22	8-25	8-28	10-35	14-40	18-45
	Tipo B	25-30	25-35	28-40	30-50	40-60	45-80	50-100

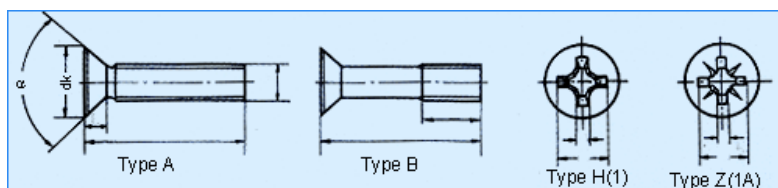
**TORNILLO DE CABEZA AVELLANADA PLANA**
**DIN 965**

		mm						
Rosca		M3	M3.5	M4	M5	M6	M8	M10
dk		5.6	6.5	7.5	9.2	11	14.5	18
k		1.65	1.93	2.2	2.5	3	4	5
Cruz	(Tipo H)m	2.9	3.9	4.4	4.6	6.6	8.7	9.6
	(Tipo Z)m	2.8	3.7	4	4.4	6.1	8.5	9.4
	No	1	2	2	2	3	4	4
L	Tipo A	6-22	6-22	8-25	8-28	10-35	14-40	18-45
	Tipo B	25-30	25-35	28-40	30-50	40-60	45-80	50-100

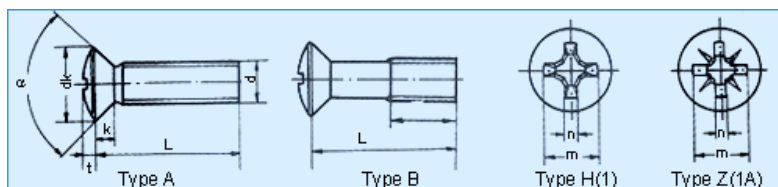
**TORNILLO DE CABEZA AVELLANADA ALOMADA**
**DIN 966**

		mm						
Rosca		M3	M3.5	M4	M5	M6	M8	M10
dk		5.6	6.5	7.5	9.2	11	14.5	18
k		1.65	1.93	2.2	2.5	3	4	5
f		0.75	0.9	1	1.25	1.5	2	2.5
Cruz	(Tipo H)m	3.1	4.2	4.5	5.3	6.8	9	10
	(Tipo Z)m	3.1	4.3	4.6	5.3	7	8.8	9.9
	NO	1	2	2	2	3	4	4
L	Tipo A	6-22	6-22	8-25	8-28	10-35	14-40	18-45
	Tipo B	25-30	25-35	28-40	30-50	40-60	45-80	50-100

## TORNILLOS PARA MADERA

### TORNILLO PARA MADERA CABEZA PLANA RANURADA

**DIN 97**

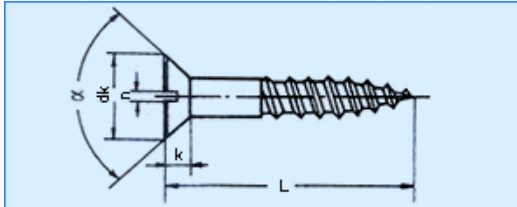

mm

Rosca	2.5	3	3.5	4	4.5	5	5.5	6
dk	4.7	5.6	6.5	7.5	8.3	9.2	10.2	11
k	1.5	1.65	1.93	2.2	2.35	2.5	2.75	3
n	0.6	0.8	0.8	1	1	1.2	1.2	1.6
L	8-25	10-40	12-40	16-50	20-60	20-100	30-100	40-100

### TORNILLO ROSCA MADERA CABEZA GOTA DE SEBO RANURADA

**DIN 95**

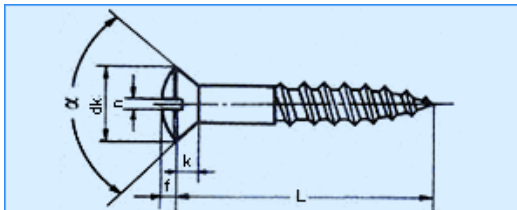

mm

Rosca	2.5	3	3.5	4	4.5	5	5.5	6
dk	4.7	5.6	6.5	7.5	8.3	9.2	10.2	11
f	0.6	0.75	0.9	1	1.1	1.25	1.4	1.5
k	1.5	1.65	1.93	2.2	2.35	2.5	2.75	3
n	0.6	0.8	0.8	1	1	1.2	1.2	1.6
L	8-25	10-40	12-40	16-50	20-60	20-100	30-100	40-100

### TORNILLO ROSCA MADERA CABEZA REDONDA RANUDARADO

**DIN 96**

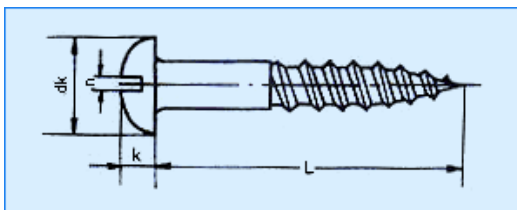

mm

Rosca	2.5	3	3.5	4	4.5	5	5.5	6
dk	5	6	7	8	9	10	11	12
K	1.7	2.1	2.4	2.8	3.1	3.5	3.8	4.2
n	0.6	0.8	0.8	1	1	1.2	1.2	1.6
L	8-25	10-40	12-40	16-50	20-60	20-100	30-100	40-100

**TORNILLOS DE MADERA CABEZA PLANA AVELLANADA**

**DIN 7997**

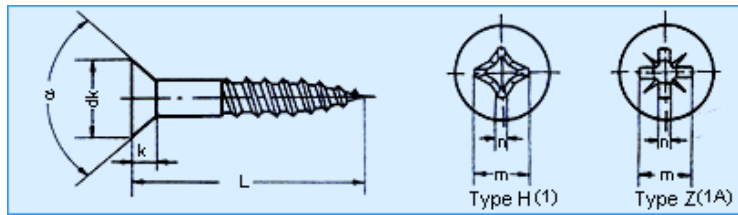

		mm							
Rosca		2.5	3	3.5	4	4.5	5	5.5	6
dk		4.7	5.6	6.5	7.5	8.3	9.2	10.2	11
k		1.5	1.65	1.93	2.2	2.35	2.5	2.75	3
Cruz	(Tipo H) m	2.7	2.9	3.9	4.4	4.6	4.8	6.2	6.6
	(Tipo Z) m	2.8	3	4	4.2	4.4	5	6.1	6.3
	No	1	1	2	2	2	3	3	3
L		10-25	10-40	12-45	16-50	20-60	20-100	30-100	40-100

**TORNILLO ROSCA MADERA CABEZA REDONDA**

**DIN 7996**

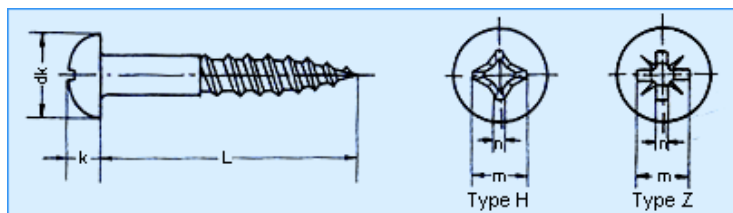

		mm							
Rosca		2.5	3	3.5	4	4.5	5	5.5	6
dk		5	6	7	8	9	10	11	12
k		1.7	2.1	2.35	2.8	3.1	3.5	3.8	4.2
Cruz	(Tipo H) m	2.3	2.7	3.7	4.1	4.4	4.8	6.2	6.6
	(Tipo Z) m	2.4	2.9	3.9	4.1	4.3	4.7	6.2	6.7
	No	1	1	2	2	2	2	3	3
L		10-25	10-40	12-40	16-50	20-60	20-100	30-100	40-100

**TORNILLO ROSCA MADERA CABEZA GOTA DE SEBO**

**DIN 7995**

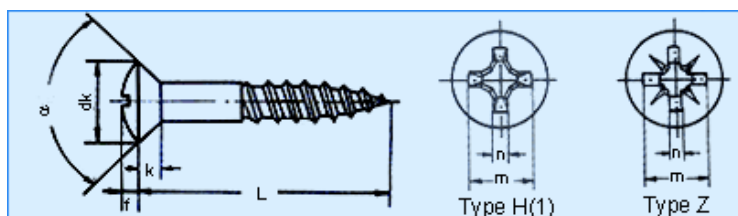

		mm							
Rosca		2.5	3	3.5	4	4.5	5	5.5	6
dk		4.7	5.6	6.5	7.5	8.3	9.2	10.2	11
f		0.6	0.75	0.9	1	1.1	1.25	1.4	1.5
k		1.5	1.65	1.93	2.2	2.35	2.5	2.75	3
Cruz	(Tipo H) m	2.7	3.1	4.2	4.5	5	5.3	7.1	7.4
	(Tipo Z) m	2.8	3.1	4.3	4.6	5.1	5.3	6.6	7
	No	1	1	2	2	2	3	3	3
L		10-25	10-40	12-40	16-50	20-60	20-100	30-100	40-100



**TORNILLO ROSCA MADERA CABEZA PLANA AVELLANADA**

**B.S. 1210**

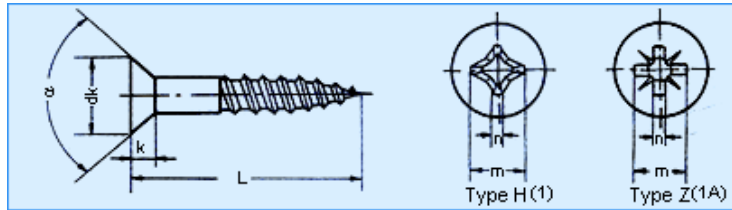

inches

Rosca	4	5	6	7	8	9	10	
dk	5.21	5.90	6.58	7.24	7.93	8.59	9.28	
f	0.66	0.76	0.81	0.91	1.02	1.17	1.19	
k	1.62	1.85	2.08	2.31	2.54	2.76	2.97	
Cruz	(Tipo Z) m	3.12	3.81	4.32	4.65	5.00	5.08	5.28
	NO	1	1	2	2	2	2	2
L	1/2-1	1/2-1 1/4	1/2-2	3/4-2	3/4-3	3/4-3	3/4-3 1/2	

**TORNILLO ROSCA MADERA CABEZA PLANA AVELLANADA**

**B.S. 1210**

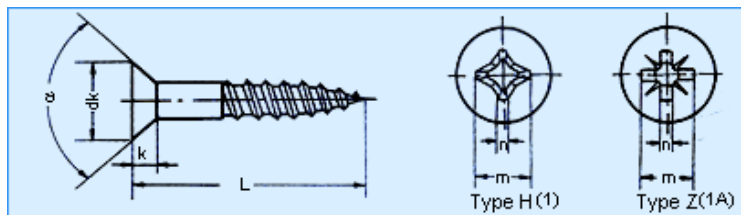

inches

Rosca	3	4	5	6	7	8	9	10	12	14	16
dk	4.55	5.21	5.90	6.56	7.24	7.93	8.59	9.28	10.62	11.99	13.31
k	1.39	1.62	1.88	2.08	2.31	2.54	2.76	2.97	3.42	3.88	4.31
(Tipo Z) m	2.51	2.74	3.50	4.22	4.22	4.60	4.60	4.98	6.35	6.60	7.49
Cruz No	1	1	2	2	2	2	2	2	3	3	3
L	1/2-5/8	1/2-2	1/2-1 1/4	1/2-2	3/4-2	3/4-3	3/4-3	3/4-3 1/2	1-5	1 1/2-5	1 1/2-5

**EURO TORNILLO**

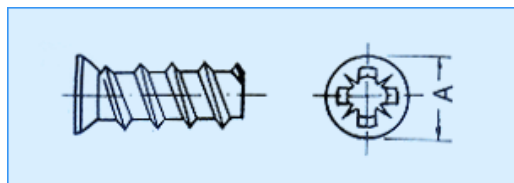

mm

Diametro nominal	6.3	6.3
Longitud	9-13	9-13
A	7	8

### TORNILLO DE CONEXIÓN DE CABEZA PLANA AVELLANADA

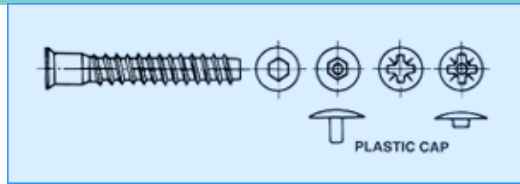

	mm		
Diametro nominal	5	7	6.3
Longitud	40-60	40-80	40-80

### TORNILLOS CONECTORES DE CABEZA PLANA

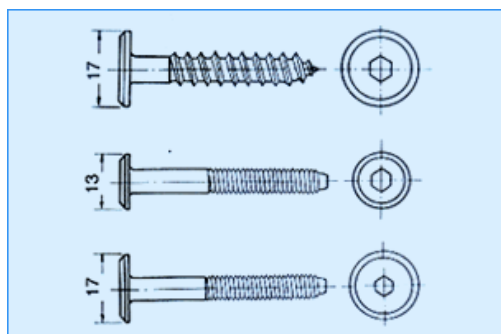

Diametro nominal	M6-1.0	1/4-20	6.3
Longitud	20-120	20-120	20-120

### TORNILLOS CONECTORES DE CABEZA REDONDA

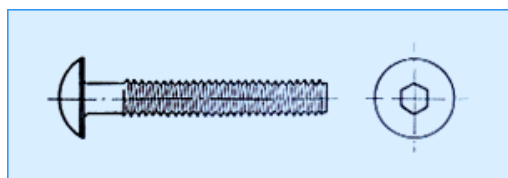

Diametro nominal	M6-1.0	1/4-20
Longitud	20-120	20-120

**TORNILLOS ROSCA MADERA CABEZA HEXAGONAL**

**DIN 571**

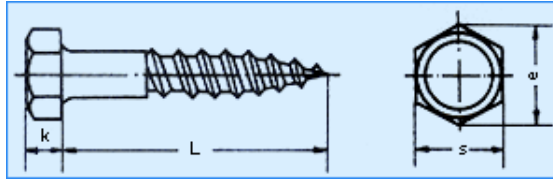

	mm							
Rosca	4	5	6	7	8	10	12	16
k	2.8	3.5	4	5	5.5	7	8	10
e	7.50	8.63	10.89	13.07	14.2	18.72	20.88	26.17
s	7	8	10	12	13	17	19	24
L	16-40	16-50	25-150	30-150	30-200	30-300	35-400	50-420

**ACOUSTICALL EYELAGS**

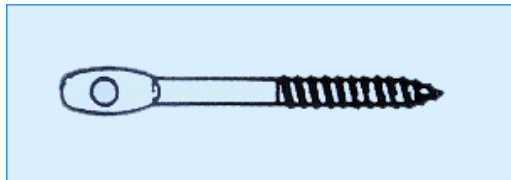

	inches		
Diametro nominal	1/4 x 3"	1/4 x 4"	1/4 x 5"

**TORNILLO DOBLE ROSCA METAL-MADERA**

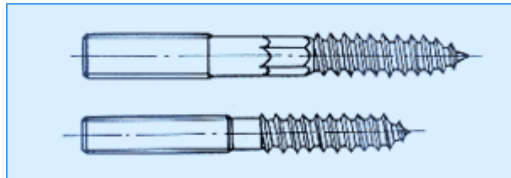

	mm
Diámetro nominal	M8-12
Longitud	50-200

**TORNILLO DOBLE ROSCA MADERA-MADERA**

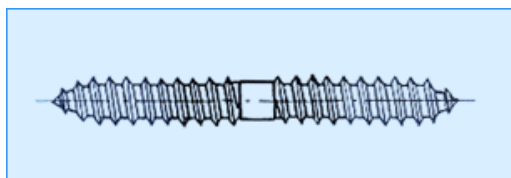

Diámetro nominal	3.5-6.3
Longitud	25-80

## TORNILLO TWINFAST PARA MADERA

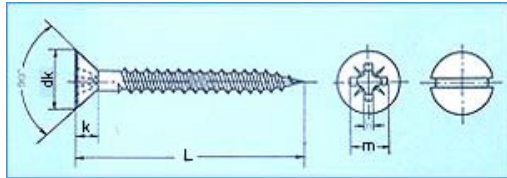

Rosca		4	5	6	7	8	10	12
dk		5.48	6.19	6.90	7.62	8.33	9.75	11.17
k		1.66	1.90	2.13	2.36	2.53	3.01	3.44
n		0.86	1.06	1.06	1.06	1.26	1.26	1.66
Cruz	No	1	2	2	2	2	2	3
	m	2.74	3.50	4.22	4.22	4.60	4.98	6.35
L(in)		1/4-1	5/16-1 1/4	7/16-2	1/2-2 1/4	5/8-3	3/4-4	1-4

mm

## TORNILLOS PARA CHAPA

### TORNILLO ROSCA CHAPA CABEZA CILINDRICA

DIN 7971

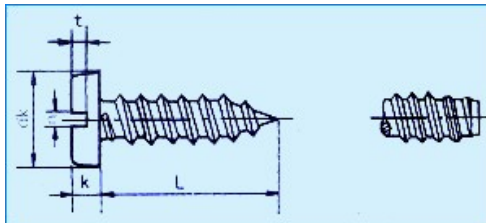

Rosca	2.9	3.5	3.9	4.2	4.8	5.5	6.3
dk	5.6	6.9	7.5	8.2	9.5	10.8	12.5
k	1.5	1.85	2	2.15	2.5	2.85	3.2
m	0.8	1	1	1.2	1.2	1.6	1.6
L(mm)	6.5-25	6.5-50	9.5-50	9.5-63	9.5-63	13-75	13-75

mm

### TORNILLO ROSCA CHAPA CABEZAPLANA AVELLANADA

DIN 7972

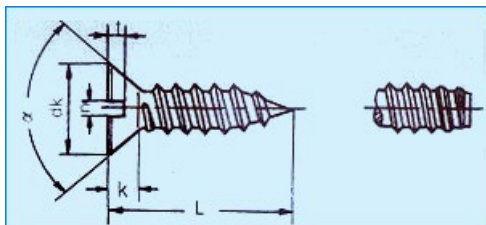

Rosca	2.9	3.5	3.9	4.2	4.8	5.5	6.3
dk	5.5	6.8	7.5	8.1	9.5	10.8	12.4
k	1.7	2.1	2.3	2.5	3	3.4	3.8
n	0.8	1	1	1.2	1.2	1.6	1.6
L	6.5-25	6.5-50	9.5-50	9.5-63	9.5-63	13-75	13-75

mm



**TORNILLO ROSCA CHAPA CABEZA DE GOTA DE SEBO**

**DIN 7973**

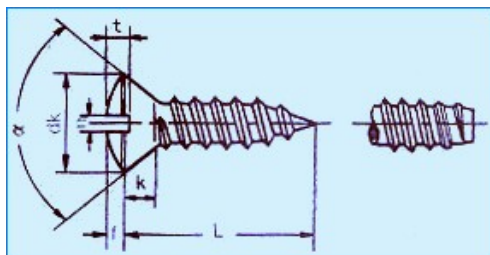

Rosca	2.9	3.5	3.9	4.2	4.8	5.5	6.3
dk	5.5	6.8	7.5	8.1	9.5	10.8	12.5
f	0.9	1.2	1.3	1.4	1.5	1.7	2
k	1.7	2.1	2.3	2.5	3	3.4	3.8
n	0.8	1	1	1.2	1.2	1.6	1.6
L	6.5-25	6.5-50	9.5-50	9.5-63	9.5-63	13-75	13-75

mm

**TORNILLOS AUTO-ROSCANTES**

**DIN 7504**

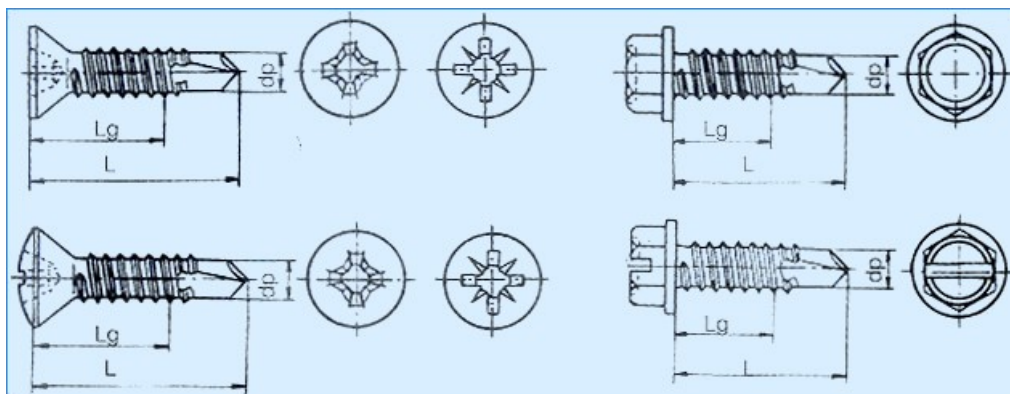

Rosca	ST2.9	ST3.5	ST4.2	ST4.8	ST5.5	ST6.3
dp	2.3	2.8	3.6	4.1	4.8	5.8
Lg	12.5	18.1	29.0	39.5	8-39	7-38
L	6.5-25	6.5-50	9.5-50	9.5-63	13-75	13-75

mm

**TORNILLO ROSCA CHAPA CABEZA PLANA AVELLANADA**

**DIN 7982**

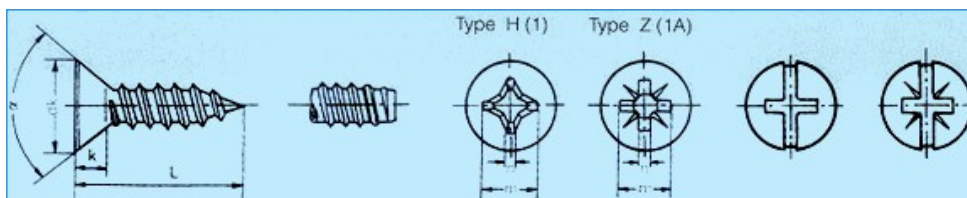

Rosca	2.9	3.5	3.9	4.2	4.8	5.5	6.3
dk	5.5	6.8	7.5	8.1	9.5	10.8	12.4
k	1.7	2.1	2.3	2.5	3	3.4	3.8
Cruz	(Tipo H) m	3	4.2	4.6	4.7	5.1	5.8
	(Tipo Z) m	2.8	4	4.2	4.4	5	6.3
	No	1	1	2	2	2	3
L	6.5-25	6.5-50	9.5-50	9.5-63	9.5-63	13-75	13-75

mm

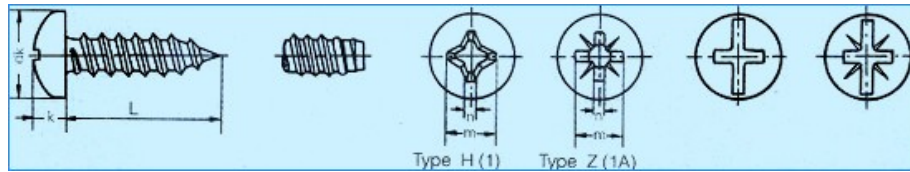
**TORNILLO ROSCA CHAPA CABEZA REDONDA**
**DIN 7981**

		mm						
Rosca		2.9	3.5	3.9	4.2	4.8	5.5	6.3
Paso		5.6	6.9	7.5	8.2	9.5	10.8	12.5
k		2.2	2.6	2.8	3.05	1.55	3.95	4.55
Cruz	(Tipo H)m	3	4.2	4.4	4.6	5	6.5	7.1
	(Tipo Z)m	2.9	3.9	4.1	4.3	4.7	6.2	6.7
	No	1	1	2	2	2	3	3
L		6.5-25	6.5-50	9.5-50	9.5-63	9.5-63	13-75	13-75

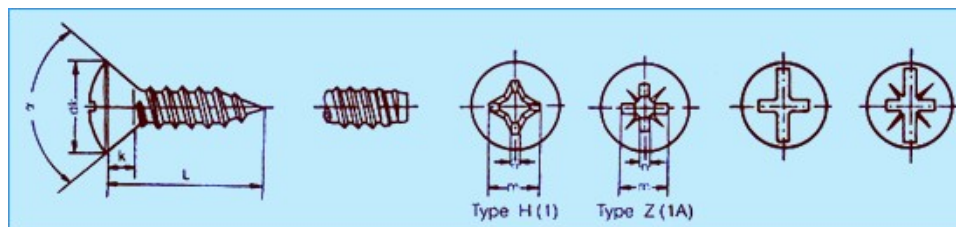
**TORNILLO ROSCA CHAPA CABEZA GOTA DE SEBO**
**DIN 7983**

		mm						
Rosca		2.9	3.5	3.9	4.2	4.8	5.5	6.3
dk		5.5	6.8	7.5	8.1	9.5	10.8	12.4
f		0.9	1.2	1.3	1.4	1.5	1.7	2
k		1.7	2.1	2.3	2.5	3	3.4	3.8
Cruz	(Tipo H) m	3.4	4.6	4.7	4.9	5.4	7	7.4
	(Tipo Z) m	3.1	4.3	4.4	4.6	5.1	6.6	7.1
	No	1	1	2	2	2	3	3
L		6.5-25	6.5-50	9.5-50	9.5-63	9.5-63	13-75	13-75

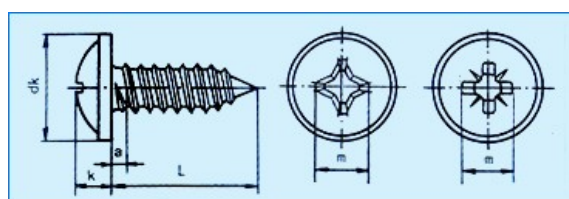
**TORNILLOS DE ESTRELLA ROSCA CHAPA CON COLLAR**
**DIN 968**

		mm					
Rosca		ST2.9	ST3.5	ST4.2	ST4.8	ST5.5	ST6.3
dk		7.50	9.00	10.0	11.5	13.0	14.5
k		2.35	2.60	3.05	3.55	3.80	4.55
Cruz	(Tipo H) m	3.00	4.20	4.60	5.00	6.50	7.10
	(Tipo Z) m	2.90	3.90	4.30	4.70	6.20	6.70
	No	1	2	2	2	3	3
L		6.5-19	9.5-25	9.5-32	9.5-50	13-50	13-50

**TORNILLO TWINFAST DE ESTRELLA CABEZA DE TROMPETA**

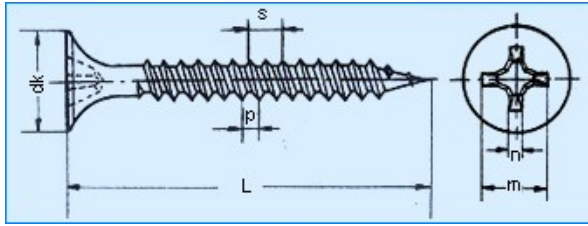

Rosca	Roscas/in	dk	Cruz		L(in)
			No	m	
6	18	8.4	2	4.9	3/4-2 1/2
7	16	8.4	2	4.9	1-2 1/2
8	15	8.4	2	4.9	2-4

**TORNILLOS FERM ACEL CON COSTILLAS DEBAJO DE LA CABEZA**

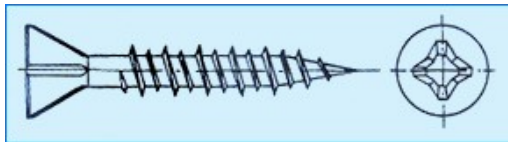

**TORNILLO ROSCA CHAPA CABEZA HEXAGONAL BRIDADO**

**DIN 6928**

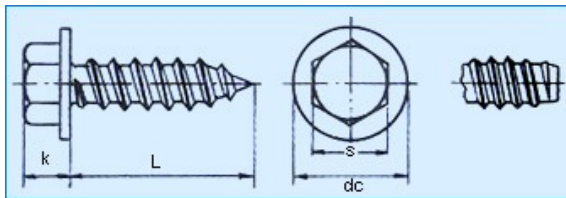

Rosca	mm					
	ST2.9	ST3.5	ST4.2	ST4.8	ST6.3	ST8.0
dc	6.30	8.30	8.80	10.5	13.5	18.0
k	2.80	3.40	4.0	4.30	5.90	7.00
s	4.00	5.50	7.00	8.00	10.0	13.0
L	6.5-25	6.5-50	9.5-50	9.5-63	13-75	13-75

**TORNILLO ROSCA CHAPA CABEZA HEXAGONAL**

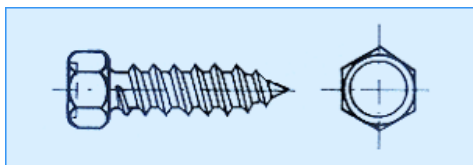

Dimensión nominal	4.2	4.8	5.5	6.3	8 <sup>#</sup>	10 <sup>#</sup>	12 <sup>#</sup>	1/4
Longitud	9.5-50	13-75	16-100	16-120	3/8-2	1/2-3	3/4-4	3/4-5

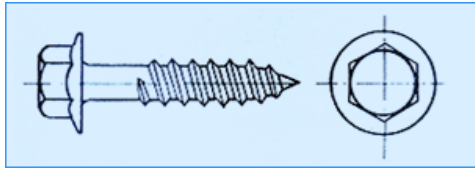

**TORNILLO ROSCA CHAPA HEXAGONAL BRIDADO MEDIA ROSCA**

Dimensión nominal	5.5	6.3	12 <sup>#</sup>	14 <sup>#</sup>
Longitud	16-120	16-180	16-120	16-180

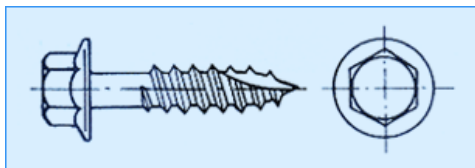
**TORNILLO AUTOBROCANTE CABEZA HEXAGONAL BRIDADO**

Dimensión nominal	12 <sup>#</sup>	1/4	5.5	6.3
Longitud	1-5	1 1/2-5	25-120	30-120

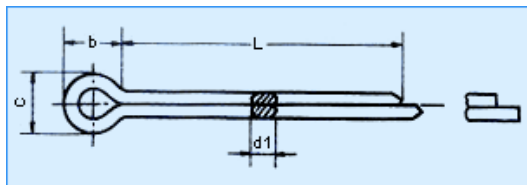
**PASADORES, REMACHES Y ANCLAJES**
**PASADOR DE ALETAS**
**DIN 94**

Dimensión nominal	2	2.5	3.2	4	5	6.3	8	10
d1	1.8	2.3	2.9	3.7	4.6	5.9	7.5	9.5
b	4	5	6.4	8	10	12.6	16	20
c	3.2	4	5.1	6.5	8	10.3	13.1	16.6
L	10-40	12-50	18-80	20-125	20-125	28-140	36-140	56-140

mm

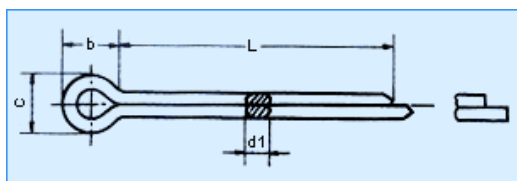
**PASADOR DE ALETAS**
**ISO 1234**

Dimension nominal	1	1.2	1.6	2	2.5	3.2	4	5	6.3	8	10
d1	0.8	0.9	1.3	1.7	2.1	2.7	3.5	4.4	5.7	7.3	9.3
b	3	3	3.2	4	5	6.4	8	10	12.6	16	20
c	1.8	2	2.8	3.6	4.6	5.8	7.4	9.2	11.8	15	19
L	6-20	8-20	8-20	10-20	12-50	18-80	20-80	20-80	28-80	36-80	56-80

mm

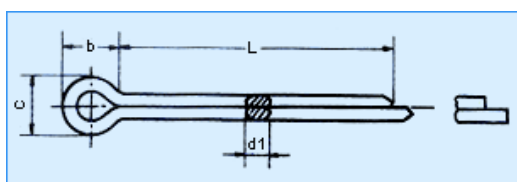
**PASADOR DE ALETAS**
**B.S.**

Dimension nominal	3/32	7/64	1/8	9/64	5/32	11/64	3/16	7/32	1/4	9/32	5/16	3/8
d1	2.11	2.57	2.70	3.36	3.51	4.09	4.40	5.29	5.69	6.86	6.29	9.10
b	4.83	5.59	6.35	7.11	7.87	8.64	9.65	11.18	12.7	14.22	15.75	19.05
c	4.72	5.48	6.29	7.11	7.87	8.68	9.44	11.07	12.64	14.22	15.97	18.94
L(in)	3/8-7/8	3/8-2	1/2-3	1/2-3	5/8-3	5/8-3	5/8-3	3/4-3	3/4-3	1 1/2-3	1 1/2-3	1 1/2-3

inches

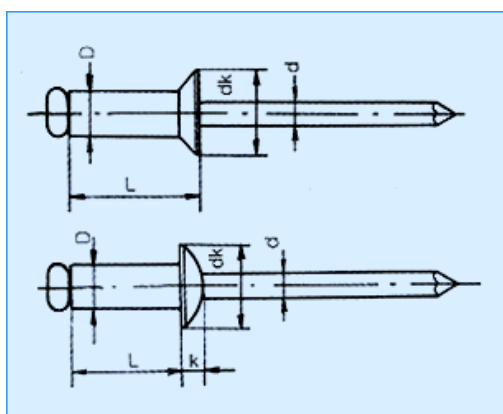
**REMACHE CIEGO**

Dimensión nominal	3	3.2	4	4.8	5
L	4.8-16	4.8-18	4.8-22	6.4-30	6.4-30
dk	6	6	8	9.5	9.5
k	1	1	1.4	1.5	1.5
d	1.8	1.8	2.2	2.6	2.8

mm

## REMACHE CIEGO HERMÉTICO DE ALUMINIO

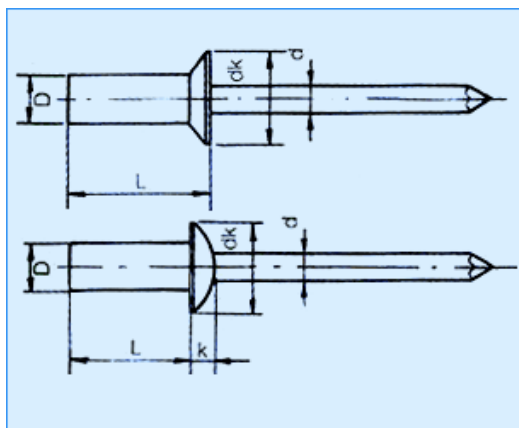

Dimension nominal	3.2	4	4.8	5
L	5-18	5-22	8-30	8-30
dk	6	8	9.5	9.5
k	1	1.4	1.5	1.5
d	1.7	2.2	2.64	2.8

mm

## PERNOS DE ANCLAJE

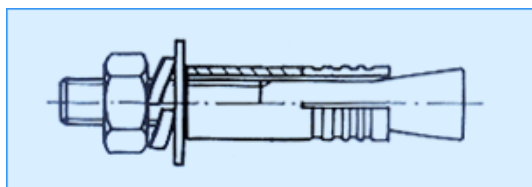

Rosca	M6	M8	M10	M12	M16	M20	M22	M24
-------	----	----	-----	-----	-----	-----	-----	-----

## CUT ANCHORS

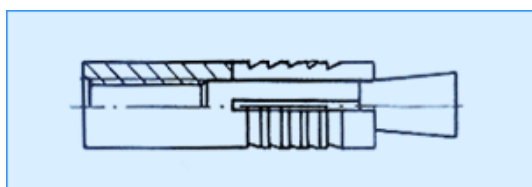

Diametro nominal	M6	M8	M10	M12	M16	M20	M22
Longitud	30	35	40	52	63	83	93

mm



## PERNOS DE ANCLAJE DE CAMISA

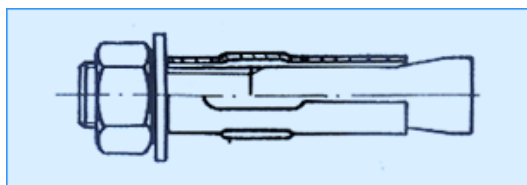

mm

Diametro nominal	6.5	8	10	12	16	20
------------------	-----	---	----	----	----	----

## PERNO DE EXPANSIÓN TIPO CUÑA

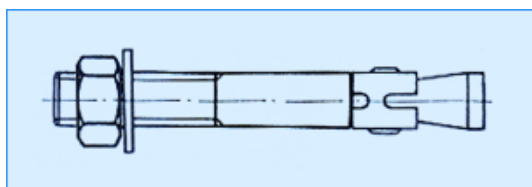

mm

Diametro nominal	M6	M8	M10	M12	M16	M20
Longitud	49-95	50-220	65-250	75-250	90-250	90-300

## PERNO DE ANCLAJE DE CABLES

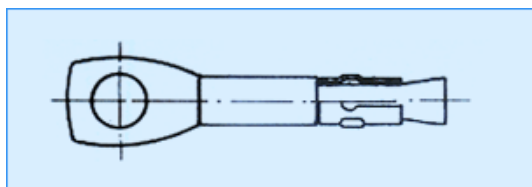

mm

Diametro nominal	6	6
Longitud	60	67

## TACO DE EXPANSIÓN

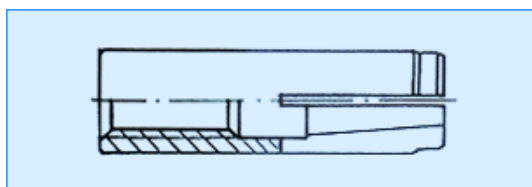

mm

Diametro nominal	M6	M8	M10	M12	M16	M20
Longitud	25	30	40	50	65	80



## PERNOS DE ANCLAJE DE ALTA RESISTENCIA

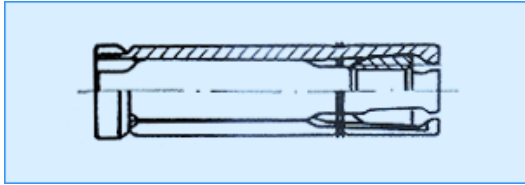

Diametro nominal	M6	M8	M10	M12	M16	M20
Longitud	45	55	60	75	115	130

mm

## TACOS DE NYLON

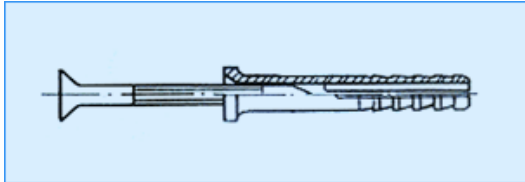

Diametro nominal	5	6	8
Longitud	20-50	35-80	60-135

mm

## VARILLAS ROSCADAS Y OTROS

### VARILLAS ROSCADAS

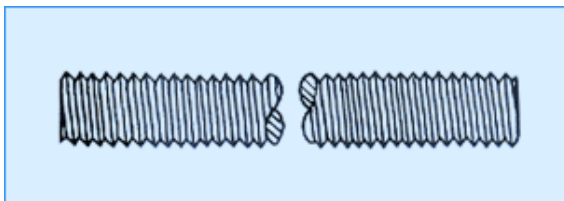

Rosca	M6	M8	M10	M12	M14	M16	M18	M20	M22	M24
Longitud	1000mm-40000mm									

mm

Rosca	1/4	5/16	3/8	7/16	1/2	9/16	5/8	3/4	7/8	1
Longitud	3feet-12feet									

inches

**ABRAZADERAS PARA CABLES DE ACERO**

**DIN 741**

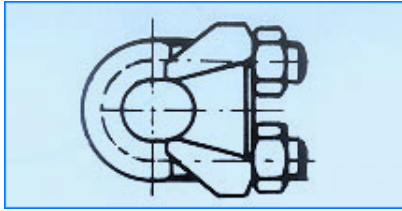

Diametro cable	3	5	6.5	8	10	11	13	14	16
Rosca	M4	M5	M5	M6	M8	M8	M10	M10	M12

mm

**TAPONES DE TUBO DE CABEZA HEXAGONAL**

**DIN 910**

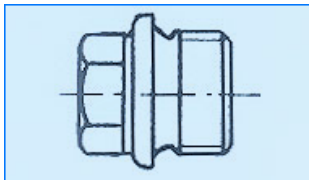

Rosca	M10	M12	M14	M16	M18	M20	M22	M24	M26	M30	M36
-------	-----	-----	-----	-----	-----	-----	-----	-----	-----	-----	-----

**ACCESORIOS PARA ANDAMIAJES**

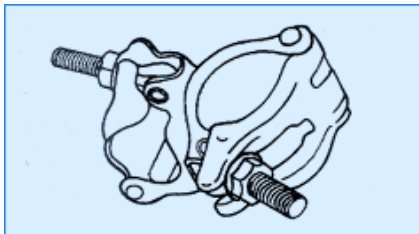

**ENGRASADORES HIDRAULICOS (ALEMITES)**

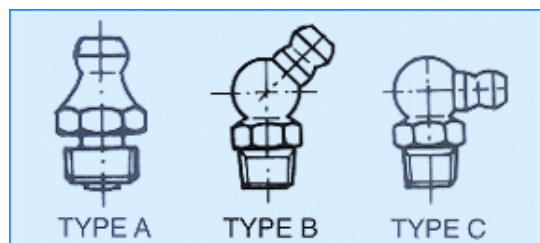

Tamaño de rosca	6×1	8×1	8×1.25	10×1
-----------------	-----	-----	--------	------

mm

## **PRODUCTOS RELACIONADOS**

[Arandelas](#), [Pernos y tornillos](#), [Tuercas](#), [Varillas roscadas](#), [Pistones de gas](#),

## **CONTACTO:**

En **Gestión de Compras** trabajamos con un amplio rango de proveedores en diferentes sectores, que nos permiten ofrecerle los productos que usted necesite al mejor precio y la máxima calidad garantizada.

Consulte con nosotros sobre cualquier producto. Contamos con el personal altamente cualificado para asesorarle.

**C/ Marzo, 9**

**02002 Albacete (Spain)**

**Phone: + (34) 967 221 602**

**Fax: + (34) 967 223 369**

**Email: [info@gestiondecompras.com](mailto:info@gestiondecompras.com)**