

HOT RUNNER SYSTEMS

Disponemos de una amplia variedad de canales calientes, cámaras calientes-distribuidores, boquillas, resistencias helicoidales, resistencias conformables, cartuchos calefactores, termopares junto a controladores de temperatura para dar un sistema completo de colada caliente y mejorar así la eficiencia de los moldes.





点浇口系列 Hot Tip (单点) single tip

PST		
PST-S		
PST-M	4-5	
PST-L	6-7	
	8-9	
PST- I		
PST- I -S	10	
PST- I -M	11-12	
PST- I -L	13-14	
PST- II		
PST- II -S	15	
PST- II -M	16	
PST- II -L	17	

(多点) Multi tips

PMT		
PMT-S	18-19	
PMT-M	20-21	
PMT-L	22-23	
PMT- I		
PMT- I -S	24	
PMT- I -M	25-26	
PMT- I -L	27-28	
PMT- II		
PMT- II -S	29	
PMT- II -M	30	
PMT- II -L	31	

大水口系列 Hot Sprue (单点) single tip

STHSB		
STHSB-S	32-33	
STHSB-M	34-35	
STHSB-L	36-37	
STHSB- I		
STHSB- I -M	38-39	
STHSB- I -L	40-41	

(多点) Multi tips

MTHSB		
MTHSB-S	42-43	
MTHSB-M	44-45	
MTHSB-L	46-47	
MTHSB- I		
MTHSB- I -M	48-49	
MTHSB- I -L	50-51	

针阀系列 Valve Gate (单点) single tip

VGST		
VGST-S	52	
VGST-M	53	
VGST-L	54	

(多点) Multi tips

VGMT		
VGMT-L	55	
VGMT- I -M	56	

注：
命名方式：

PST-S : 单点点浇口小流量
PST-M : 单点点浇口中流量
PST-L : 单点点浇口大流量
PMT-S : 多点点浇口小流量
PMT-M : 多点点浇口中流量
PMT-L : 多点点浇口大流量
STHSB : 单点大水口
MTHSB : 多点大水口
VGST : 单点针阀式浇口
VGMT : 多点针阀式浇口

Remarks:

Model Nr. name way:

PST-S : Point gate Single Tip hot nozzle Small size
PST-M : Point gate Single Tip hot nozzle Medium size
PST-L : Point gate Single Tip hot nozzle Large size
PMT-S : Point gate Multi Tips hot nozzle Small size
PMT-M : Point gate Multi Tips hot nozzle Medium size
PMT-L : Point gate Multi Tips hot nozzle Large size
STHSB : Single Tip Hot Sprue Bush
MTHSB : Multi Tips Hot Sprue Bush
VGST : Valve Gate Single Tip
VGMT : Valve Gate Multi Tips

PST-S

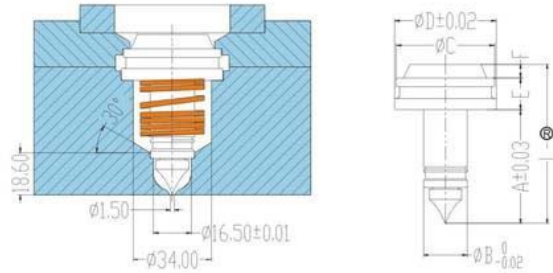
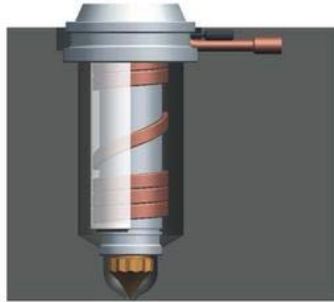

注：“R”为膨胀量 “R” referring heat expending rate

PST-S	A	B	C	D	E	F	L	加热圈长度 Coil heater & length	功率 Power	铜套加热圈 Copper sleeve coil
PST-S19-70	50	19	42.4	44	14	6	70	φ19x35	350W	
PST-S19-80	60	19	42.4	44	14	6	80	φ19x45	420W	
PST-S19-90	70	19	42.4	44	14	6	90	φ19x55	500W	
PST-S19-100	80	19	42.4	44	14	6	100	φ19x65	530W	
PST-S19-110	90	19	42.4	44	14	6	110	φ19x75	650W	460W
PST-S19-120	100	19	42.4	44	14	6	120	φ19x85	760W	500W

*以上喷嘴加热圈功率在900W以下的，其直条截面尺寸是：X * Y = 4.2 * 2.2mm (X为宽度，Y为厚度)
 *以上喷嘴加热圈功率在900W以上的，根据喷嘴的要求，其直条截面尺寸另定。
 *以上喷嘴热电偶为J型。
 *以上参数若有改动，恕难及时通知。

*Above nozzle, the coiled heater diameter indication is meaning the inner diameter.
 *Above nozzle, the coiled heater power below 900W, the section dimension is 4.2x2.2mm (width x thickness). If the power over 900W, heater's section dimension will be same or subject to change.
 *Above nozzle, the thermocouple is J type.
 *Above parameter is subject to change without notice.

特点，优点：

- 杰出的设计，保证换色迅速，最大可能地减少热量散失。
 - 表面有针点痕迹的进料口。
 - 适用于高流动性塑料的成型。
 - 德国电加热元件和热电偶。
 - 德国进口钢料经过精湛的热处理和合理精确的加工工艺。
 - 经过4道尺寸和温控的严格检验。
- outstanding design guaranteed fast color changes & prevented heating transfer to the mold.
 - on the plastic parts surface, there is pin point mark.
 - suitable for high melting flow index material injection.
 - German origin heating elements and thermocouple.
 - German steel by correct harden treatment and precision tooling processing.
 - Each nozzle from the beginning until the well finished, there are 4 times dimension controlling and temperature controlling inspections

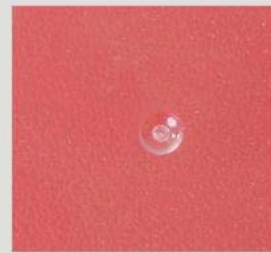

*用该喷嘴注塑成型后的浇口效果图

PST-M

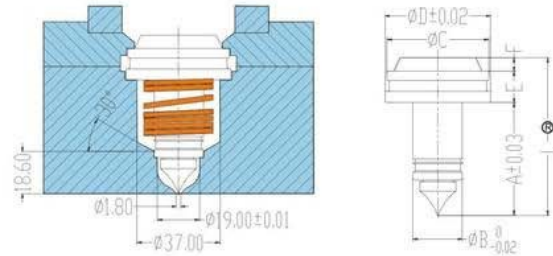
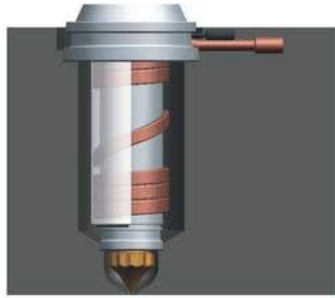

注：“R”为膨胀量 “R” referring heat expending rate

PST-M	A	B	C	D	E	F	L	加热圈长度 Coil heater ϕ & length	功率 Power	铜套加热圈 Copper sleeve coil
PST-M22-70	50	22	45.4	47	14	6	70	$\phi 22 \times 35$	380W	
PST-M22-80	60	22	45.4	47	14	6	80	$\phi 22 \times 45$	460W	
PST-M22-90	70	22	45.4	47	14	6	90	$\phi 22 \times 55$	530W	
PST-M22-100	80	22	45.4	47	14	6	100	$\phi 22 \times 65$	650W	420W
PST-M22-110	90	22	45.4	47	14	6	110	$\phi 22 \times 75$	760W	500W
PST-M22-120	100	22	45.4	47	14	6	120	$\phi 22 \times 85$	840W	530W
PST-M22-130	110	22	45.4	47	14	6	130	$\phi 22 \times 95$	840W	570W
PST-M22-140	120	22	45.4	47	14	6	140	$\phi 22 \times 105$	840W	650W

*以上喷嘴加热圈功率在900W以下的，其直条截面尺寸是：X * Y = 4.2 * 2.2mm (X为宽度，Y为厚度)
*以上喷嘴加热圈功率在900W以上的，根据喷嘴的要求，其直条截面尺寸另定。

*以上喷嘴热电偶为J型。

*以上参数若有改动，恕难及时通知。

*Above nozzle, the coiled heater diameter indication is meaning the inner diameter.

*Above nozzle, the coiled heater power below 900W, the section dimension is 4.2x2.2mm (width x thickness). If the power over 900W, heater's section dimension will be same or subject to change.

*Above nozzle, the thermocouple is J type.

*Above parameter is subject to change without notice.

特点、优点：

- 杰出的设计，保证换色迅速，最大可能地减少热量散失。
- 表面有针点痕迹的进料口。
- 适用于高流动性塑料的成型。
- 德国电加热元件和热电偶。
- 德国进口钢料经过精湛的热处理和合理精确的加工工艺。
- 经过4道尺寸和温控的严格检验。

- outstanding design guaranteed fast color changes & prevented heating transfer to the mould.
- on the plastic parts surface, there is pin point mark.
- suitable for high melting flow index material injection.
- German origin heating elements and thermocouple.
- German steel by correct harden treatment and precision tooling processing.
- Each nozzle from the beginning until the well finished, there are 4 times dimension controlling and temperature controlling inspections



*用该喷嘴注塑成型后的浇口效果图

PST-M

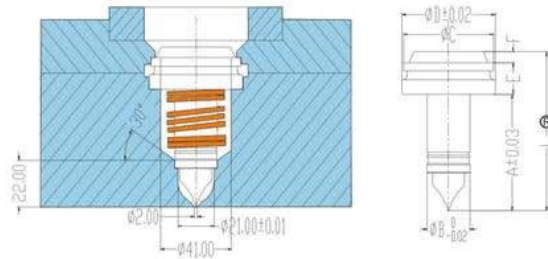
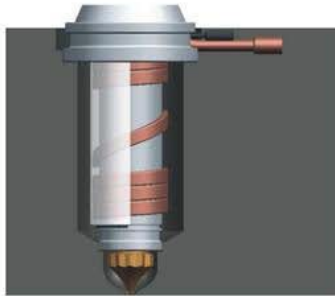

注：“R”为膨胀量 “R” referring heat expanding rate

PST-M	A	B	C	D	E	F	L	加热圈长度 Coil heater ϕ & length	功率 Power	铜套加热圈 Copper sleeve coil
PST-M25-75	55	25	52	54	15	5	75	ϕ 25x35	420W	
PST-M25-85	65	25	52	54	15	5	85	ϕ 25x45	500W	
PST-M25-95	75	25	52	54	15	5	95	ϕ 25x55	570W	420W
PST-M25-105	85	25	52	54	15	5	105	ϕ 25x65	650W	460W
PST-M25-115	95	25	52	54	15	5	115	ϕ 25x75	760W	530W
PST-M25-125	105	25	52	54	15	5	125	ϕ 25x85	840W	610W
PST-M25-135	115	25	52	54	15	5	135	ϕ 25x95	840W	690W
PST-M25-145	125	25	52	54	15	5	145	ϕ 25x105	840W	760W

*以上喷嘴加热圈功率在900W以下的，其直条截面尺寸是：X * Y = 4.2 * 2.2mm (X为宽度，Y为厚度)
 *以上喷嘴加热圈功率在900W以上的，根据喷嘴的要求，其直条截面尺寸另定。
 *以上喷嘴热电偶为J型。
 *以上参数若有改动，恕难及时通知。

*Above nozzle, the coiled heater diameter indication is meaning the inner diameter.
 *Above nozzle, the coiled heater power below 900W, the section dimension is 4.2x2.2mm (width x thickness). If the power over 900W, heater's section dimension will be same or subject to change.
 *Above nozzle, the thermocouple is J type.
 *Above parameter is subject to change without notice.

特点，优点：

- 杰出的设计，保证换色迅速，最大可能地减少热量散失。
- 表面有针点痕迹的进料口。
- 适用于高流动性塑料的成型。
- 德国电加热元件和热电偶。
- 德国进口钢料经过精湛的热处理和合理精确的加工工艺。
- 经过4道尺寸和温控的严格检验。
- outstanding design guaranteed fast color change & prevented heating transfer to the mould
- on the plastic parts surface, there is pin point mark
- suitable for high melting flow index material injection
- German origin heating elements and thermocouple
- German steel by correct harden treatment and precision tooling processing
- Each nozzle from the beginning until the well finished, there are 4 times dimension controlling and temperature controlling inspections



*用该喷嘴注塑成型后的浇口效果图

PST-L

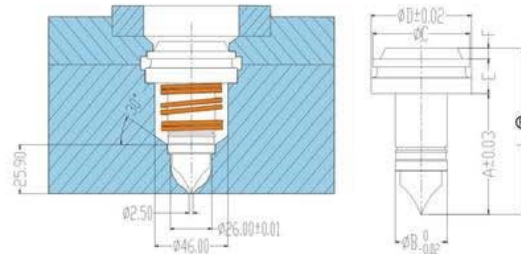

注：“R”为膨胀量 “R” referring heat expanding rate

PST-L	A	B	C	D	E	F	L	加热圈长度 Coil heater \varnothing & length	功率 Power
PST-L30-80	58	30	56	58	17	5	80	待定 to be determined	待定 to be determined
PST-L30-90	68	30	56	58	17	5	90		
PST-L30-100	78	30	56	58	17	5	100		
PST-L30-110	88	30	56	58	17	5	110		
PST-L30-120	98	30	56	58	17	5	120		
PST-L30-130	108	30	56	58	17	5	130		
PST-L30-140	118	30	56	58	17	5	140		
PST-L30-150	128	30	56	58	17	5	150		
PST-L30-160	138	30	56	58	17	5	160		
PST-L30-170	148	30	56	58	17	5	170		

*以上喷嘴加热圈功率在900W以下的，其直条截面尺寸是：X * Y = 4.2 * 2.2mm (X为宽度，Y为厚度)
 *以上喷嘴加热圈功率在900W以上的，根据喷嘴的要求，其直条截面尺寸另定。
 *以上喷嘴热电偶为J型。
 *以上参数若有改动，恕难及时通知。

*Above nozzle, the coiled heater diameter indication is meaning the inner diameter.
 *Above nozzle, the coiled heater power below 900W, the section dimension is 4.2x2.2mm (width x thickness). If the power over 900W, heater's section dimension will be same or subject to change.
 *Above nozzle, the thermocouple is J type.
 *Above parameter is subject to change without notice.

特点，优点：

- 杰出的设计，保证换色迅速，最大可能地减少热量散失。
- 表面有针点痕迹的进料口。
- 适用于高流动性塑料的成型。
- 德国电加热元件和热电偶。
- 德国进口钢料经过精湛的热处理和合理精确的加工工艺。
- 经过4道尺寸和温控的严格检验。

- outstanding design guaranteed fast color changes & prevented heating transfer to the mould.
- on the plastic parts surface, there is pin point mark.
- suitable for high melting flow index material injection.
- German origin heating elements and thermocouple.
- German steel by correct harden treatment and precision tooling processing.
- Each nozzle from the beginning until the well finished, there are 4 times dimension controlling and temperature controlling inspections



*用该喷嘴注塑成型后的浇口效果图

PST-L

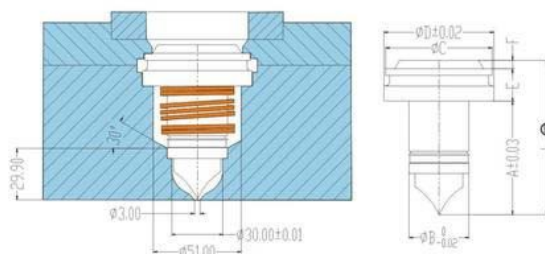
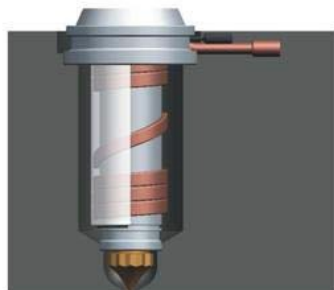

注：“R”为膨胀量 “R” referring heat expending rate

PST-L	A	B	C	D	E	F	L	加热圈长度 Coil heater ϕ & length	功率 Power
PST-L35-90	66	35	62	64	19	5	90	待定 to be determined	待定 to be determined
PST-L35-100	76	35	62	64	19	5	100		
PST-L35-110	86	35	62	64	19	5	110		
PST-L35-120	96	35	62	64	19	5	120		
PST-L35-130	106	35	62	64	19	5	130		
PST-L35-140	116	35	62	64	19	5	140		
PST-L35-150	126	35	62	64	19	5	150		
PST-L35-160	136	35	62	64	19	5	160		
PST-L35-170	146	35	62	64	19	5	170		
PST-L35-180	156	35	62	64	19	5	180		

*以上喷嘴加热圈功率在900W以下的，其直条截面尺寸是：X * Y = 4.2 * 2.2mm (X为宽度，Y为厚度)

*以上喷嘴加热圈功率在900W以上的，根据喷嘴的要求，其直条截面尺寸另定。

*以上喷嘴热电偶为J型。

*以上参数若有改动，恕难及时通知。

*Above nozzle, the coiled heater diameter indication is meaning the inner diameter.

*Above nozzle, the coiled heater power below 900W, the section dimension is 4.2x2.2mm (width x thickness). If the power over 900W, heater's section dimension will be same or subject to change.

*Above nozzle, the thermocouple is J type.

*Above parameter is subject to change without notice.

特点，优点：

- 杰出的设计，保证换色迅速，最大可能地减少热量散失。
- 表面有针点痕迹的进料口。
- 适用于高流动性塑料的成型。
- 德国电加热元件和热电偶。
- 德国进口钢料经过精湛的热处理和合理精确的加工工艺。
- 经过4道尺寸和温控的严格检验。

- outstanding design guaranteed fast color changes & prevented heating transfer to the mould.
- on the plastic parts surface, there is pin point mark.
- suitable for high melting flow index material injection.
- German origin heating elements and thermocouple.
- German steel by correct harden treatment and precision tooling processing.
- Each nozzle from the beginning until the well finished, there are 4 times dimension controlling and temperature controlling inspections

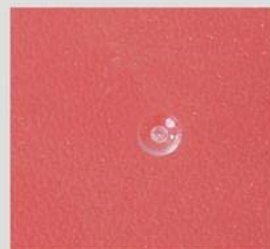

*用该喷嘴注塑成型后的浇口效果图

PST- I -S

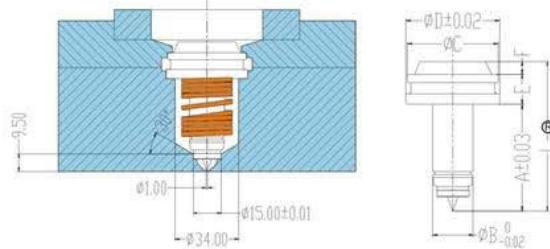
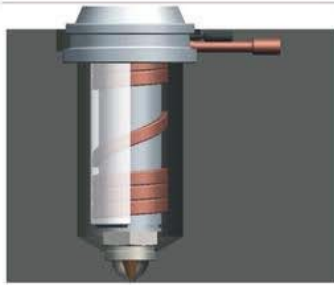

注：“R”为膨胀量 “R” referring heat expending rate

PST- I -S	A	B	C	D	E	L	加热圈长度 Coil heater ϕ & length	功率 Power	铜套加热圈 Copper sleeve coil
PST- I -S19-70	50	19	42.2	44	14	70	ϕ 19x35	350W	
PST- I -S19-80	60	19	42.2	44	14	80	ϕ 19x45	420W	
PST- I -S19-90	70	19	42.2	44	14	90	ϕ 19x55	500W	
PST- I -S19-100	80	19	42.2	44	14	100	ϕ 19x65	530W	
PST- I -S19-110	90	19	42.2	44	14	110	ϕ 19x75	650W	460W
PST- I -S19-120	100	19	42.2	44	14	120	ϕ 19x85	760W	500W

*以上喷嘴加热圈功率在900W以下的，其直条截面尺寸是：X * Y = 4.2 * 2.2mm (X为宽度， Y为厚度)
 *以上喷嘴加热圈功率在900W以上的，根据喷嘴的要求，其直条截面尺寸另定。
 *以上喷嘴热电偶为J型。
 *以上参数若有改动，恕难及时通知。

*Above nozzle, the coiled heater diameter indication is meaning the inner diameter.
 *Above nozzle, the coiled heater power below 900W, the section dimension is 4.2x2.2mm (width x thickness). If the power over 900W, heater's section dimension will be same or subject to change.
 *Above nozzle, the thermocouple is J type.
 *Above parameter is subject to change without notice.

特点，优点：

- 杰出的设计，保证换色迅速，最大可能地减少热量散失。
- 表面有针点痕迹的进料口。
- 适用于高流动性塑料的成型。
- 德国电加热元件和热电偶。
- 德国进口钢料经过精湛的热处理和合理精确的加工工艺。
- 经过4道尺寸和温控的严格检验。
- outstanding design guaranteed fast color change & prevented heating transfer to the mould.
- on the plastic parts surface, there is pin point mark.
- suitable for high melting flow index material injection.
- German origin heating elements and thermocouple.
- German steel by correct harden treatment and precision tooling processing.
- Each nozzle from the beginning until the well finished, there are 4 times dimension controlling and temperature controlling inspections.



*用该喷嘴注塑成型后的浇口效果图

PST- I -M

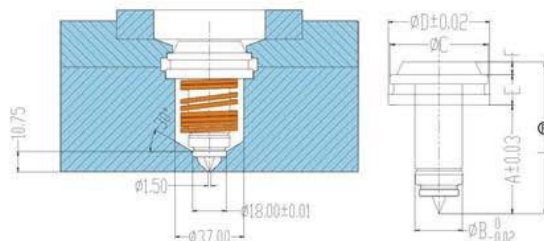
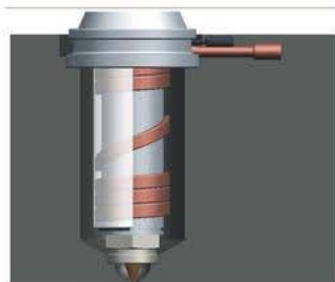

注：“R”为膨胀量 “R” referring heat expending rate

PST- I -M	A	B	C	D	E	F	L	加热圈长度 Coiled heater & length	功率 Power	铜套加热圈 Copper sleeve coil
PST- I -M22-70	50	22	45.4	47	14	6	70	φ22x35	380W	
PST- I -M22-80	60	22	45.4	47	14	6	80	φ22x45	460W	
PST- I -M22-90	70	22	45.4	47	14	6	90	φ22x55	500W	
PST- I -M22-100	80	22	45.4	47	14	6	100	φ22x65	610W	420W
PST- I -M22-110	90	22	45.4	47	14	6	110	φ22x75	650W	460W
PST- I -M22-120	100	22	45.4	47	14	6	120	φ22x85	840W	530W
PST- I -M22-130	110	22	45.4	47	14	6	130	φ22x95	840W	570W
PST- I -M22-140	120	22	45.4	47	14	6	140	φ22x105	840W	650W

*以上喷嘴加热圈功率在900W以下的，其直条截面尺寸是：X * Y = 4.2 * 2.2mm (X为宽度，Y为厚度)
 *以上喷嘴加热圈功率在900W以上的，根据喷嘴的要求，其直条截面尺寸另定。
 *以上喷嘴热电偶为J型。
 *以上参数若有改动，恕难及时通知。

*Above nozzle, the coiled heater diameter indication is meaning the inner diameter.
 *Above nozzle, the coiled heater power below 900W, the section dimension is 4.2x2.2mm (width x thickness). If the power over 900W, heater's section dimension will be same or subject to change.
 *Above nozzle, the thermocouple is J type.
 *Above parameter is subject to change without notice.

特点，优点：

- 杰出的设计，保证换色迅速，最大可能地减少热量散失。
- 表面有针点痕迹的进料口。
- 适用于高流动性塑料的成型。
- 德国电加热元件和热电偶。
- 德国进口钢材经过精湛的热处理和合理精确的加工工艺。
- 经过4道尺寸和温控的严格检验。
- outstanding design guaranteed fast color changements & prevented heating transfer to the mould.
- on the plastic parts surface, there is pin point mark.
- suitable for high melting flow index material injection.
- German origin heating elements and thermocouple.
- German steel by correct harden treatment and precision tooling processing.
- Each nozzle from the beginning until the well finished, there are 4 times dimension controlling and temperature controlling inspections



*用该喷嘴注塑成型后的浇口效果图

PST- I -M

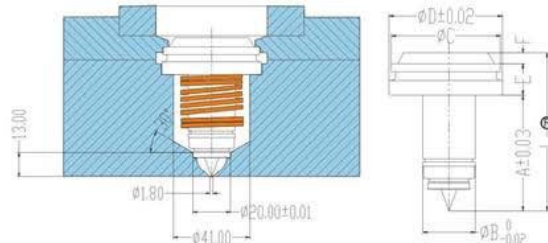

注：“R”为膨胀量 “R” referring heat expending rate

PST- I -M	A	B	C	D	E	L	加热圈长度 Coiled heater & length	功率 Power	铜套加热圈 Copper sleeve coil
PST- I -M22-75	55	25	52	54	15	75	φ25x35	420W	
PST- I -M22-85	65	25	52	54	15	85	φ25x45	500W	
PST- I -M22-95	75	25	52	54	15	95	φ25x55	570W	420W
PST- I -M22-105	85	25	52	54	15	105	φ25x65	650W	460W
PST- I -M22-115	95	25	52	54	15	115	φ25x75	760W	530W
PST- I -M22-125	105	25	52	54	15	125	φ25x85	840W	610W
PST- I -M22-135	115	25	52	54	15	135	φ25x95	840W	690W
PST- I -M22-145	125	25	52	54	15	145	φ25x105	840W	760W

*以上喷嘴加热圈功率在900W以下的，其直条截面尺寸是：X * Y=4.2*2.2mm（X为宽度，Y为厚度）
 *以上喷嘴加热圈功率在900W以上的，根据喷嘴的要求，其直条截面尺寸另定。
 *以上喷嘴热电偶为J型。
 *以上参数若有改动，恕难及时通知。

*Above nozzle, the coiled heater diameter indication is meaning the inner diameter.
 *Above nozzle, the coiled heater power below 900W, the section dimension is 4.2x2.2mm (width x thickness).if the power over 900W, heater's section dimension will be same or subject to change.
 *Above nozzle, the thermocouple is J type.
 *Above parameter is subject to change without notice.

特点，优点：

- 杰出的设计，保证换色迅速，最大可能地减少热量散失。
- 表面有针点痕迹的进料口。
- 适用于高流动性塑料的成型。
- 德国电加热元件和热电偶。
- 德国进口钢料经过精湛的热处理和合理精确的加工工艺。
- 经过4道尺寸和温控的严格检验。
- outstanding design guaranteed fast color changements & prevented heating transfer to the mould.
- on the plastic parts surface, there is pin point mark.
- suitable for high melting flow index material injection.
- German origin heating elements and thermocouple.
- German steel by correct harden treatment and precision tooling processing.
- Each nozzle from the beginning until the well finished, there are 4 times dimension controlling and temperature controlling inspections



*用该喷嘴注塑成型后的浇口效果图

PST- I -L

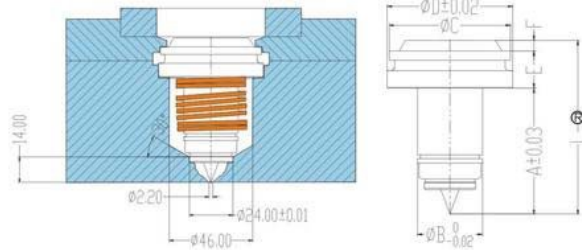
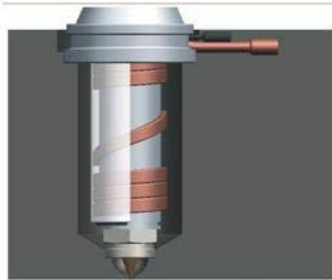

注：“R”为膨胀量 “R” referring heat expending rate

PST- I -L	A	B	C	D	E	F	L	加热圈长度 Coil heater ϕ & length	功率 Power
PST- I -L30-80	58	30	56	58	17	5	80	待定 to be determined	待定 to be determined
PST- I -L30-90	68	30	56	58	17	5	90		
PST- I -L30-100	78	30	56	58	17	5	100		
PST- I -L30-110	88	30	56	58	17	5	110		
PST- I -L30-120	98	30	56	58	17	5	120		
PST- I -L30-130	108	30	56	58	17	5	130		
PST- I -L30-140	118	30	56	58	17	5	140		
PST- I -L30-150	128	30	56	58	17	5	150		
PST- I -L30-160	138	30	56	58	17	5	160		
PST- I -L30-170	148	30	56	58	17	5	170		

*以上喷嘴加热圈功率在900W以下的，其直条截面尺寸是：X * Y = 4.2 * 2.2mm (X为宽度，Y为厚度)
 *以上喷嘴加热圈功率在900W以上的，根据喷嘴的要求，其直条截面尺寸另定。
 *以上喷嘴热电偶为J型。
 *以上参数若有改动，恕难及时通知。

*Above nozzle, the coiled heater diameter indication is meaning the inner diameter.
 *Above nozzle, the coiled heater power below 900W, the section dimension is 4.2x2.2mm (width x thickness). If the power over 900W, heater's section dimension will be same or subject to change.
 *Above nozzle, the thermocouple is J type.
 *Above parameter is subject to change without notice.

特点，优点：

- 杰出的设计，保证换色迅速，最大可能地减少热量散失。
- 表面有针点痕迹的进料口。
- 适用于高流动性塑料的成型。
- 德国电加热元件和热电偶。
- 德国进口钢料经过精湛的热处理和合理精确的加工工艺。
- 经过4道尺寸和温控的严格检验。
- outstanding design guaranteed fast color changes & prevented heating transfer to the mould.
- on the plastic parts surface, there is pin point mark.
- suitable for high melting flow index material injection.
- German origin heating elements and thermocouple.
- German steel by correct harden treatment and precision tooling processing.
- Each nozzle from the beginning until the well finished, there are 4 times dimension controlling and temperature controlling inspections

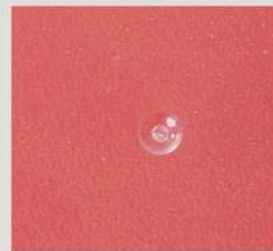

*用该喷嘴注塑成型后的浇口效果图

PST- I -L

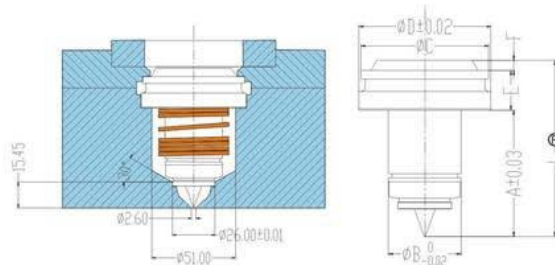

注：“R”为膨胀量 “R” referring heat expending rate

PST- I -L	A	B	C	D	E	F	L	加热圈长度 Coil heater & length	功率 Power
PST- I -L35-85	61	35	62	64	19	5	90	待定 to be determined	待定 to be determined
PST- I -L35-95	71	35	62	64	19	5	100		
PST- I -L35-105	81	35	62	64	19	5	110		
PST- I -L35-115	91	35	62	64	19	5	120		
PST- I -L35-125	101	35	62	64	19	5	130		
PST- I -L35-135	111	35	62	64	19	5	140		
PST- I -L35-145	121	35	62	64	19	5	150		
PST- I -L35-155	131	35	62	64	19	5	160		
PST- I -L35-165	141	35	62	64	19	5	170		
PST- I -L35-175	151	35	62	64	19	5	180		

*以上喷嘴加热圈功率在900W以下的，其直条截面尺寸是：X*Y=4.2*2.2mm（X为宽度，Y为厚度）

*以上喷嘴加热圈功率在900W以上的，根据喷嘴的要求，其直条截面尺寸另定。

*以上喷嘴热电偶为J型。

*以上参数若有改动，恕难及时通知。

*Above nozzle, the coiled heater diameter indication is meaning the inner diameter.

*Above nozzle, the coiled heater power below 900W, the section dimension is 4.2x2.2mm (width x thickness). If the power over 900W, heater's section dimension will be same or subject to change.

*Above nozzle, the thermocouple is J type.

*Above parameter is subject to change without notice.

特点. 优点:

- 杰出的设计，保证换色迅速，最大可能地减少热量散失。
- 表面有针点痕迹的进料口。
- 适用于高流动性塑料的成型。
- 德国电加热元件和热电偶。
- 德国进口钢材经过精湛的热处理和合理精确的加工工艺。
- 经过4道尺寸和温控的严格检验。

- outstanding design guaranteed fast color changelements & prevented heating transfer to the mould.
- on the plastic parts surface, there is pin point mark.
- suitable for high melting flow index material injection.
- German origin heating elements and thermocouple.
- German steel by correct harden treatment and precision tooling processing.
- Each nozzle from the beginning until the well finished, there are 4 times dimension controlling and temperature controlling inspections



*用该喷嘴注塑成型后的浇口效果图

PST-II-S

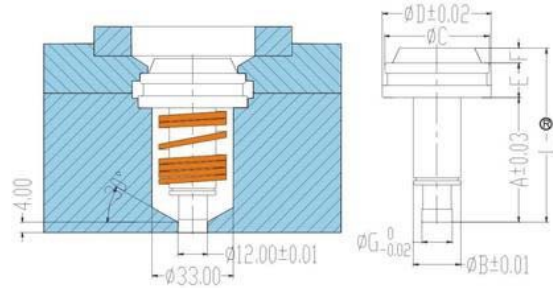
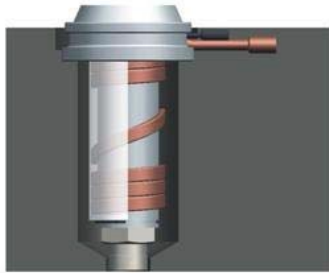

注：“R”为膨胀量 “R” referring heat expanding rate

PST-II-S	A	B	C	D	E	F	G	L	加热圈长度 Coil heater ϕ & length	功率 Power	铜套加热圈 Copper sleeve coil
PST-II-S19-70	50	19	42.2	44	14	6	12	70	ϕ 19x40	380W	
PST-II-S19-80	60	19	42.2	44	14	6	12	80	ϕ 19x50	460W	
PST-II-S19-90	70	19	42.2	44	14	6	12	90	ϕ 19x60	530W	
PST-II-S19-100	80	19	42.2	44	14	6	12	100	ϕ 19x70	610W	420W
PST-II-S19-110	90	19	42.2	44	14	6	12	110	ϕ 19x80	690W	460W
PST-II-S19-120	100	19	42.2	44	14	6	12	120	ϕ 19x90	760W	500W

- *以上喷嘴加热圈功率在900W以下的，其直条截面尺寸是：X * Y = 4.2 * 2.2mm (X为宽度，Y为厚度)
- *以上喷嘴加热圈功率在900W以上的，根据喷嘴的要求，其直条截面尺寸另定。
- *以上喷嘴热电偶为J型。
- *以上参数若有改动，恕难及时通知。

- *Above nozzle, the coiled heater diameter indication is meaning the inner diameter.
- *Above nozzle, the coiled heater power below 900W, the section dimension is 4.2x2.2mm (width x thickness). If the power over 900W, heater's section dimension will be same or subject to change.
- *Above nozzle, the thermocouple is J type.
- *Above parameter is subject to change without notice.

特点，优点：

- 高流量设计，适合大面积，大体积注射。
- 换色迅速。
- 适合表面允许有料把的塑料产品。
- 适用于普通材料和工程塑料的成型。
- 适用于磨损性与含有填料的塑料成型。
- 德国电加热元件和热电偶。
- 德国进口钢料经过精湛的热处理和合理精确的加工工艺。
- 经过4道尺寸和温控的严格检验。

- suitable for big surface and big volume injection.
- excellent color change performance.
- suitable for the plastic parts which allow the gate tails on it.
- suitable for normal & engineering plastic raw material injection.
- suitable for durable, hard plastic material & Glass Fiber added plastic material injection.
- German origin heating elements and thermocouple.
- German steel by correct harden treatment and precision tooling processing.
- Each nozzle from the beginning until the well finished, there are 4 times dimension controlling and temperature controlling inspections.

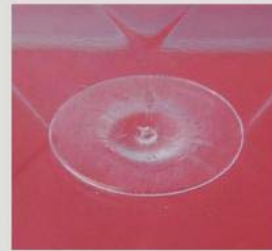

*用该喷嘴注塑成型后的浇口效果图

PST-II-M

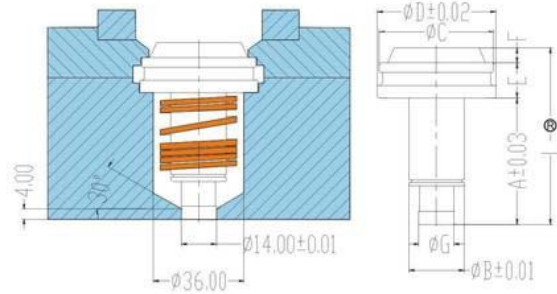
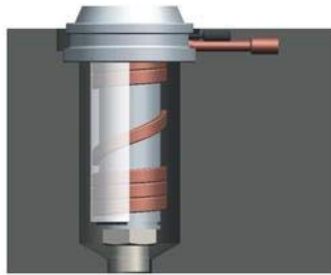

注：“R”为膨胀量 “R” referring heat expending rate

PST-II-M	A	B	C	D	E	F	G	L	加热圈长度 Coil heater φ & length	功率 Power	铜套加热圈 Copper sleeve coil
PST-II-M22-70	50	22	45.4	47	14	6	14	70	φ22x40	380W	
PST-II-M22-80	60	22	45.4	47	14	6	14	80	φ22x50	460W	
PST-II-M22-90	70	22	45.4	47	14	6	14	90	φ22x60	530W	
PST-II-M22-100	80	22	45.4	47	14	6	14	100	φ22x70	610W	460W
PST-II-M22-110	90	22	45.4	47	14	6	14	110	φ22x80	690W	500W
PST-II-M22-120	100	22	45.4	47	14	6	14	120	φ22x90	760W	530W
PST-II-M22-130	110	22	45.4	47	14	6	14	130	φ22x100	840W	570W
PST-II-M22-140	120	22	45.4	47	14	6	14	140	φ22x110	840W	650W

*以上喷嘴加热圈功率在900W以下的，其直条截面尺寸是：X*Y=4.2*2.2mm（X为宽度，Y为厚度）

*以上喷嘴加热圈功率在900W以上的，根据喷嘴的要求，其直条截面尺寸另定。

*以上喷嘴热电偶为J型。

*以上参数若有改动，恐难及时通知。

*Above nozzle, the coiled heater diameter indication is meaning the inner diameter.

*Above nozzle, the coiled heater power below 900W, the section dimension is 4.2x2.2mm (width x thickness). If the power over 900W, heater's section dimension will be same or subject to change.

*Above nozzle, the thermocouple is J type.

*Above parameter is subject to change without notice.

特点，优点：

- 高流量设计，适合大面积，大体积注射。
- 换色迅速。
- 适合表面允许有料把的塑料产品。
- 适用于普通材料和工程塑料的成型。
- 适用于磨损性与含有填料的塑料成型。
- 德国电加热元件和热电偶。
- 德国进口钢料经过精湛的热处理和合理精确的加工工艺。
- 经过4道尺寸和温控的严格检验。

- suitable for big surface and big volume injection.
- excellent color change performance
- suitable for the plastic parts which allow the gate tails on it.
- suitable for normal & engineering plastic raw material injection.
- suitable for durable, hard plastic material & Glass Fiber added plastic material injection.
- German origin heating elements and thermocouple.
- German steel by correct harden treatment and precision tooling processing.
- Each nozzle from the beginning until the well finished, there are 4 times dimension controlling and temperature controlling inspections.

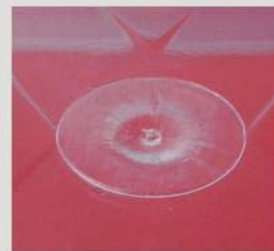

*用该喷嘴注塑成型后的浇口效果图

PST- II -L

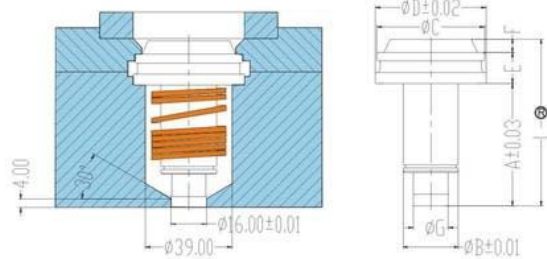
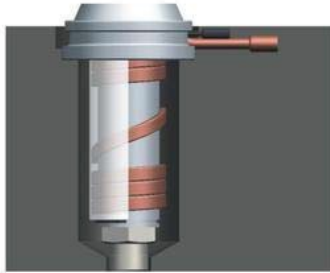

注：“R”为膨胀量 “R” referring heat expending rate

PST- II -L	A	B	C	D	E	F	G	L	加热圈长度 Coil heater ϕ & length	功率 Power	铜套加热圈 Copper sleeve coil
PST- II -L25-75	55	25	48.4	50	14	6	16	75	ϕ 25x42	500W	
PST- II -L25-85	65	25	48.4	50	14	6	16	85	ϕ 25x52	570W	
PST- II -L25-95	75	25	48.4	50	14	6	16	95	ϕ 25x62	650W	420W
PST- II -L25-105	85	25	48.4	50	14	6	16	105	ϕ 25x72	690W	460W
PST- II -L25-115	95	25	48.4	50	14	6	16	115	ϕ 25x82	760W	500W
PST- II -L25-125	105	25	48.4	50	14	6	16	125	ϕ 25x92	840W	570W
PST- II -L25-135	115	25	48.4	50	14	6	16	135	ϕ 25x102	840W	610W
PST- II -L25-145	125	25	48.4	50	14	6	16	145	ϕ 25x112	840W	690W

*以上喷嘴加热圈功率在900W以下的，其直条截面尺寸是：X * Y = 4.2 * 2.2mm (X为宽度，Y为厚度)
 *以上喷嘴加热圈功率在900W以上的，根据喷嘴的要求，其直条截面尺寸另定。
 *以上喷嘴热电偶为J型。
 *以上参数若有改动，恕难及时通知。

*Above nozzle, the coiled heater diameter indication is meaning the inner diameter.
 *Above nozzle, the coiled heater power below 900W, the section dimension is 4.2x2.2mm (width x thickness). If the power over 900W, heater's section dimension will be same or subject to change.
 *Above nozzle, the thermocouple is J type.
 *Above parameter is subject to change without notice.

特点，优点：

- 高流量设计，适合大面积，大体积注射。
- 换色迅速。
- 适合表面允许有料把的塑料产品。
- 适用于普通材料和工程塑料的成型。
- 适用于磨损性与含有填料的塑料成型。
- 德国电加热元件和热电偶。
- 德国进口钢料经过精湛的热处理和合理精确的加工工艺。
- 经过4道尺寸和温控的严格检验。
- suitable for big surface and big volume injection.
- excellent color change performance.
- suitable for the plastic parts which allow the gate tails on it.
- suitable for normal & engineering plastic raw material injection.
- suitable for durable, hard plastic material & Glass Fiber added plastic material injection.
- German origin heating elements and thermocouple.
- German steel by correct harden treatment and precision tooling processing.
- Each nozzle from the beginning until the well finished, there are 4 times dimension controlling and temperature controlling inspections.

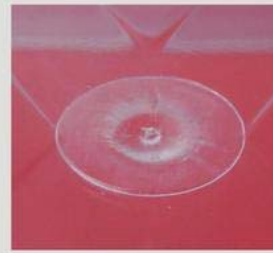

*用该喷嘴注塑成型后的浇口效果图

PMT-S

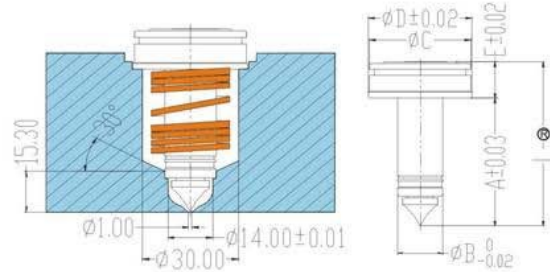
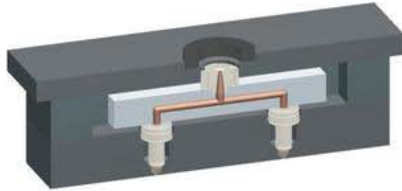

注：“R”为膨胀量 “R” referring heat expending rate

PMT-S	A	B	C	D	E	L	加热圈长度 Coil heater ϕ & length	功率 Power
PMT-S16-68	53	16	35	36	15	68	ϕ 16x35	300W
PMT-S16-75	60	16	35	36	15	75	ϕ 16x40	300W
PMT-S16-85	70	16	35	36	15	85	ϕ 16x50	350W
PMT-S16-95	80	16	35	36	15	95	ϕ 16x60	420W
PMT-S16-105	90	16	35	36	15	105	ϕ 16x70	500W
PMT-S16-115	100	16	35	36	15	115	ϕ 16x80	570W

*以上喷嘴加热圈功率在900W以下的，其直条截面尺寸是：X * Y=4.2*2.2mm（X为宽度，Y为厚度）
 *以上喷嘴加热圈功率在900W以上的，根据喷嘴的要求，其直条截面尺寸另定。
 *以上喷嘴热电偶为J型。
 *以上参数若有改动，恕难及时通知。

*Above nozzle, the coiled heater diameter indication is meaning the inner diameter.
 *Above nozzle, the coiled heater power below 900W, the section dimension is 4.2x2.2mm (width x thickness). If the power over 900W, heater's section dimension will be same or subject to change.
 *Above nozzle, the thermocouple is J type.
 *Above parameter is subject to change without notice.

特点，优点：

- 杰出的设计，保证换色迅速，最大可能地减少热量散失。
- 表面有针点痕迹的进料口。
- 适用于高流动性塑料的成型。
- 德国电加热元件和热电偶。
- 德国进口钢料经过精湛的热处理和合理精确的加工工艺。
- 经过4道尺寸和温控的严格检验。
- outstanding design guaranteed fast color changements & prevented heating transfer to the mould
- on the plastic parts surface, there is pin point mark.
- suitable for high melting flow index material injection.
- German origin heating elements and thermocouple.
- German steel by correct harden treatment and precision tooling processing.
- Each nozzle from the beginning until the well finished, there are 4 times dimension controlling and temperature controlling inspections.



*用该喷嘴注塑成型后的浇口效果图

PMT-S

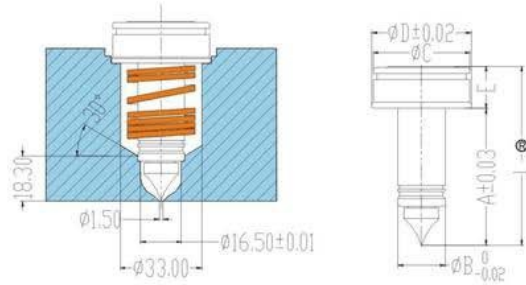
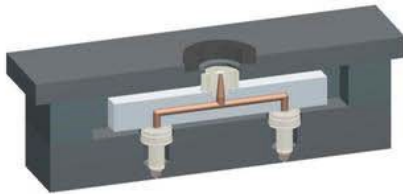

注：“R”为膨胀量 “R” referring heat expending rate

PMT-S	A	B	C	D	E	L	加热圈长度 Coil heater ϕ & length	功率 Power	铜套加热圈 Copper sleeve coil
PMT-S19-72	55	19	39	40	17	72	ϕ 19x35	350W	
PMT-S19-82	65	19	39	40	17	82	ϕ 19x45	380W	
PMT-S19-92	75	19	39	40	17	92	ϕ 19x55	420W	
PMT-S19-102	85	19	39	40	17	102	ϕ 19x65	530W	380W
PMT-S19-112	95	19	39	40	17	112	ϕ 19x75	650W	420W
PMT-S19-122	105	19	39	40	17	122	ϕ 19x85	760W	460W

*以上喷嘴加热圈功率在900W以下的，其直条截面尺寸是：X * Y = 4.2 * 2.2mm (X为宽度，Y为厚度)
 *以上喷嘴加热圈功率在900W以上的，根据喷嘴的要求，其直条截面尺寸另定。
 *以上喷嘴热电偶为J型。
 *以上参数若有改动，恐难及时通知。

*Above nozzle, the coiled heater diameter indication is meaning the inner diameter.
 *Above nozzle, the coiled heater power below 900W, the section dimension is 4.2x2.2mm (width x thickness). If the power over 900W, heater's section dimension will be same or subject to change.
 *Above nozzle, the thermocouple is J type.
 *Above parameter is subject to change without notice.

特点, 优点:

- 杰出的设计，保证换色迅速，最大可能地减少热量散失。
- 表面有针点痕迹的进料口。
- 适用于高流动性塑料的成型。
- 德国电加热元件和热电偶。
- 德国进口钢料经过精湛的热处理和合理精确的加工工艺。
- 经过4道尺寸和温控的严格检验。

- outstanding design guaranteed fast color change & prevented heating transfer to the mould.
- on the plastic parts surface, there is pin point mark.
- suitable for high melting flow index material injection.
- German origin heating elements and thermocouple.
- German steel by correct harden treatment and precision tooling processing.
- Each nozzle from the beginning until the well finished, there are 4 times dimension controlling and temperature controlling inspections.



*用该喷嘴注塑成型后的浇口效果图

PMT-M

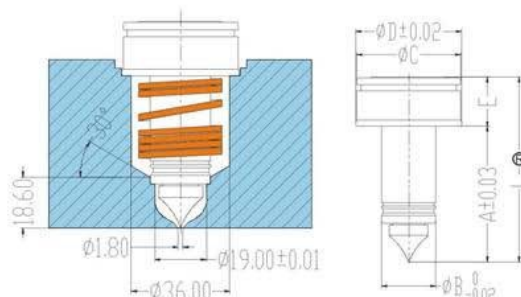
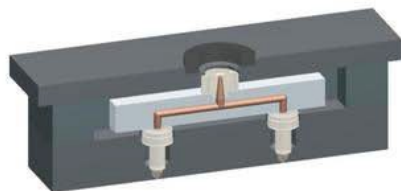

注：“R”为膨胀量 “R” referring heat expanding rate

PMT-M	A	B	C	D	E	L	加热圈长度 Cold heater ϕ & length	功率 Power	铜套加热圈 Copper sleeve coil
PMT-M22-75	55	22	42	43	20	75	$\phi 22 \times 35$	300W	
PMT-M22-85	65	22	42	43	20	85	$\phi 22 \times 45$	380W	
PMT-M22-95	75	22	42	43	20	95	$\phi 22 \times 55$	460W	
PMT-M22-105	85	22	42	43	20	105	$\phi 22 \times 65$	500W	380W
PMT-M22-115	95	22	42	43	20	115	$\phi 22 \times 75$	610W	420W
PMT-M22-125	105	22	42	43	20	125	$\phi 22 \times 85$	650W	460W
PMT-M22-135	115	22	42	43	20	135	$\phi 22 \times 95$	840W	530W
PMT-M22-145	125	22	42	43	20	145	$\phi 22 \times 105$	840W	610W

*以上喷嘴加热圈功率在900W以下的，其直条截面尺寸是：X * Y = 4.2 * 2.2mm (X为宽度，Y为厚度)
 *以上喷嘴加热圈功率在900W以上的，根据喷嘴的要求，其直条截面尺寸另定。
 *以上喷嘴热电偶为J型。
 *以上参数若有改动，恕难及时通知。

*Above nozzle, the coiled heater diameter indication is meaning the inner diameter.
 *Above nozzle, the coiled heater power below 900W, the section dimension is 4.2x2.2mm (width x thickness). If the power over 900W, heater's section dimension will be same or subject to change.
 *Above nozzle, the thermocouple is J type.
 *Above parameter is subject to change without notice.

特点、优点：

- 杰出的设计，保证换色迅速，最大可能地减少热量散失。
- 表面有针点痕迹的进料口。
- 适用于高流动性塑料的成型。
- 德国电加热元件和热电偶。
- 德国进口钢材经过精湛的热处理和合理精确的加工工艺。
- 经过4道尺寸和温控的严格检验。

- outstanding design guaranteed fast color changes & prevented heating transfer to the mould
- on the plastic parts surface, there is pin point mark.
- suitable for high melting flow index material injection.
- German origin heating elements and thermocouple.
- German steel by correct harden treatment and precision tooling processing.
- Each nozzle from the beginning until the well finished, there are 4 times dimension controlling and temperature controlling inspections



*用该喷嘴注塑成型后的浇口效果图

PMT-M

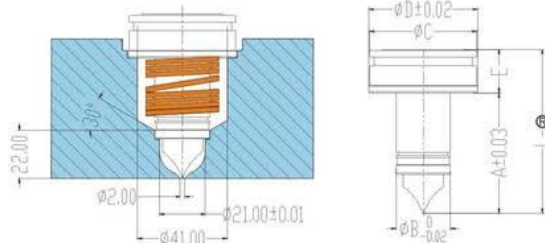
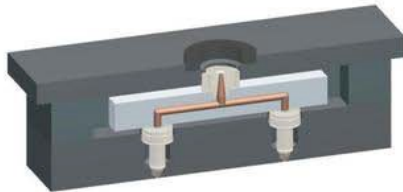

注：“R”为膨胀量 “R” referring heat expanding rate

PMT-M	A	B	C	D	E	L	加热圈长度 Coiled heater & length	功率 Power	铜套加热圈 Copper sleeve coil
PMT-M25-75	55	25	49	50	20	75	φ25x35	420W	
PMT-M25-85	65	25	49	50	20	85	φ25x45	500W	
PMT-M25-95	75	25	49	50	20	95	φ25x55	570W	420W
PMT-M25-105	85	25	49	50	20	105	φ25x65	650W	460W
PMT-M25-115	95	25	49	50	20	115	φ25x75	760W	530W
PMT-M25-125	105	25	49	50	20	125	φ25x85	840W	610W
PMT-M25-135	115	25	49	50	20	135	φ25x95	840W	690W
PMT-M25-145	125	25	49	50	20	145	φ25x105	840W	760W

*以上喷嘴加热圈功率在900W以下的，其直条截面尺寸是：X*Y=4.2*2.2mm（X为宽度，Y为厚度）
*以上喷嘴加热圈功率在900W以上的，根据喷嘴的要求，其直条截面尺寸另定。
*以上喷嘴热电偶为J型。
*以上参数若有改动，恕难及时通知。

*Above nozzle, the coiled heater diameter indication is meaning the inner diameter.
*Above nozzle, the coiled heater power below 900W, the section dimension is 4.2x2.2mm (width x thickness). If the power over 900W, heater's section dimension will be same or subject to change.
*Above nozzle, the thermocouple is J type.
*Above parameter is subject to change without notice.

特点：优点：

-杰出的设计，保证换色迅速，最大可能地减少热量散失。
-表面有针点痕迹的进料口。
-适用于高流动性塑料的成型。
-德国电加热元件和热电偶。
-德国进口钢料经过精湛的热处理和合理精确的加工工艺。
-经过4道尺寸和温控的严格检验。

-outstanding design guaranteed fast color change & prevented heating transfer to the mould
-on the plastic parts surface, there is pin point mark.
-suitable for high melting flow index material injection.
-German origin heating elements and thermocouple.
-German steel by correct harden treatment and precision tooling processing.
-Each nozzle from the beginning until the wall finished, there are 4 times dimension controlling and temperature controlling inspections



*用该喷嘴注塑成型后的浇口效果图

PMT-L

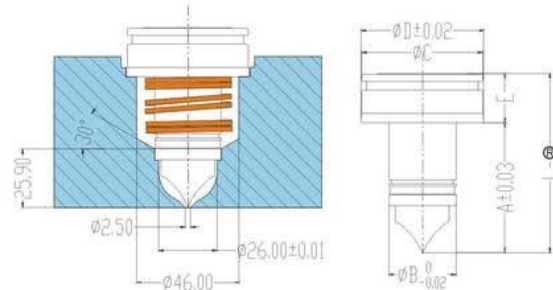
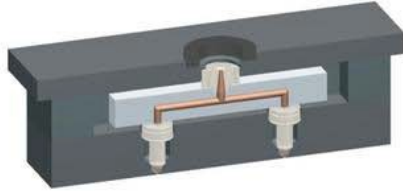

注：“R”为膨胀量 “R” referring heat expending rate

PMT-L	A	B	C	D	E	L	加热圈长度 Coil heater & length	功率 Power
PMT-L30-80	58	30	54	55	22	80	待定 to be determined	待定 to be determined
PMT-L30-90	68	30	54	55	22	90		
PMT-L30-100	78	30	54	55	22	100		
PMT-L30-110	88	30	54	55	22	110		
PMT-L30-120	98	30	54	55	22	120		
PMT-L30-130	108	30	54	55	22	130		
PMT-L30-140	118	30	54	55	22	140		
PMT-L30-150	128	30	54	55	22	150		
PMT-L30-160	138	30	54	55	22	160		
PMT-L30-170	148	30	54	55	22	170		

*以上喷嘴加热圈功率在900W以下的，其直条截面尺寸是：X * Y = 4.2 * 2.2mm (X为宽度，Y为厚度)
*以上喷嘴加热圈功率在900W以上的，根据喷嘴的要求，其直条截面尺寸另定。
*以上喷嘴热电偶为J型。
*以上参数若有改动，恕难及时通知。

*Above nozzle, the coiled heater diameter indication is meaning the inner diameter.
*Above nozzle, the coiled heater power below 900W, the section dimension is 4.2x2.2mm (width x thickness). If the power over 900W, heater's section dimension will be same or subject to change.
*Above nozzle, the thermocouple is J type.
*Above parameter is subject to change without notice.

特点，优点：

- 杰出的设计，保证换色迅速，最大可能地减少热量散失。
 - 表面有针点痕迹的进料口。
 - 适用于高流动性塑料的成型。
 - 德国电加热元件和热电偶。
 - 德国进口钢料经过精湛的热处理和合理精确的加工工艺。
 - 经过4道尺寸和温控的严格检验。
- outstanding design guaranteed fast color changes & prevented heating transfer to the mould.
 - on the plastic parts surface, there is pin point mark.
 - suitable for high melting flow index material injection.
 - German origin heating elements and thermocouple.
 - German steel by correct harden treatment and precision tooling processing.
 - Each nozzle from the beginning until the well finished, there are 4 times dimension controlling and temperature controlling inspections



*用该喷嘴注塑成型后的浇口效果图

PMT-L

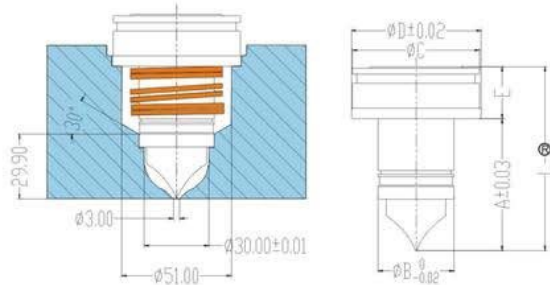
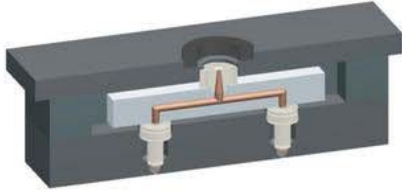

注：“R”为膨胀量 “R” referring heat expending rate

PMT-L	A	B	C	D	E	L	加热圈长度 Coil heater ϕ & length	功率 Power
PMT-L35-85	61	35	59	60	24	85	待 定 to be determined	待 定 to be determined
PMT-L35-95	71	35	59	60	24	95		
PMT-L35-105	81	35	59	60	24	105		
PMT-L35-115	91	35	59	60	24	115		
PMT-L35-125	101	35	59	60	24	125		
PMT-L35-135	111	35	59	60	24	135		
PMT-L35-145	121	35	59	60	24	145		
PMT-L35-155	131	35	59	60	24	155		
PMT-L35-165	121	35	59	60	24	145		
PMT-L35-175	131	35	59	60	24	155		

- *以上喷嘴加热圈功率在900W以下的，其直条截面尺寸是：X*Y=4.2*2.2mm（X为宽度，Y为厚度）
- *以上喷嘴加热圈功率在900W以上的，根据喷嘴的要求，其直条截面尺寸另定。
- *以上喷嘴热电偶为J型。
- *以上参数若有改动，恕难及时通知。

- *Above nozzle, the coiled heater diameter indication is meaning the inner diameter.
- *Above nozzle, the coiled heater power below 900W, the section dimension is 4.2x2.2mm (width x thickness). If the power over 900W, heater's section dimension will be same or subject to change.
- *Above nozzle, the thermocouple is J type.
- *Above parameter is subject to change without notice.

特点，优点：

- 杰出的设计，保证换色迅速，最大可能地减少热量散失。
- 表面有针点痕迹的进料口。
- 适用于高流动性塑料的成型。
- 德国电加热元件和热电偶。
- 德国进口钢料经过精湛的热处理和合理精确的加工工艺。
- 经过4道尺寸和温控的严格检验。
- outstanding design guaranteed fast color changes & prevented heating transfer to the mould
- on the plastic parts surface, there is pin point mark
- suitable for high melting flow index material injection
- German origin heating elements and thermocouple
- German steel by correct harden treatment and precision tooling processing
- Each nozzle from the beginning until the well finished, there are 4 times dimension controlling and temperature controlling inspections



*用该喷嘴注塑成型后的浇口效果图

PMT- I -S

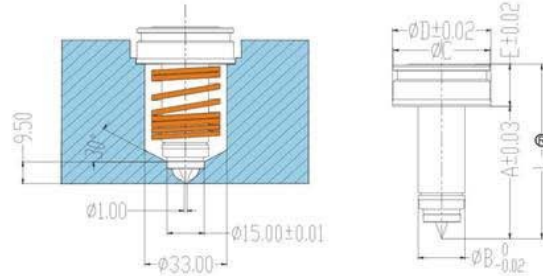
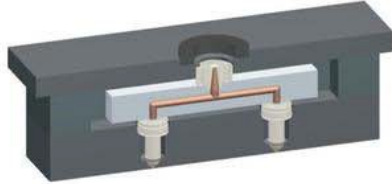

注：“R”为膨胀量 “R” referring heat expending rate

PMT- I -S	A	B	C	D	E	L	加热圈长度 Coil heater ϕ & length	功率 Power	铜套加热圈 Copper sleeve coil
PMT- I -S19-70	53	19	39	40	17	70	$\phi 19 \times 40$	350W	
PMT- I -S19-80	63	19	39	40	17	80	$\phi 19 \times 50$	380W	
PMT- I -S19-90	73	19	39	40	17	90	$\phi 19 \times 60$	420W	
PMT- I -S19-100	83	19	39	40	17	100	$\phi 19 \times 70$	530W	380W
PMT- I -S19-110	93	19	39	40	17	110	$\phi 19 \times 80$	650W	420W
PMT- I -S19-120	103	19	39	40	17	120	$\phi 19 \times 90$	760W	460W

*以上喷嘴加热圈功率在900W以下的，其直条截面尺寸是：X * Y = 4.2 * 2.2mm (X为宽度，Y为厚度)
 *以上喷嘴加热圈功率在900W以上的，根据喷嘴的要求，其直条截面尺寸另定。
 *以上喷嘴热电偶为J型。
 *以上参数若有改动，恕难及时通知。

*Above nozzle, the coiled heater diameter indication is meaning the inner diameter.
 *Above nozzle, the coiled heater power below 900W, the section dimension is 4.2x2.2mm (width x thickness). If the power over 900W, heater's section dimension will be same or subject to change.
 *Above nozzle, the thermocouple is J type.
 *Above parameter is subject to change without notice.

特点，优点：

- 杰出的设计，保证换色迅速，最大可能地减少热量散失。
- 表面有针点痕迹的进料口。
- 适用于高流动性塑料的成型。
- 德国电加热元件和热电偶。
- 德国进口钢料经过精湛的热处理和合理精确的加工工艺。
- 经过4道尺寸和温控的严格检验。
- outstanding design guaranteed fast color changes & prevented heating transfer to the mould.
- on the plastic parts surface, there is pin point mark.
- suitable for high melting flow index material injection.
- German origin heating elements and thermocouple.
- German steel by correct harden treatment and precision tooling processing.
- Each nozzle from the beginning until the well finished, there are 4 times dimension controlling and temperature controlling inspections.



*用该喷嘴注塑成型后的浇口效果图

PMT- I -M

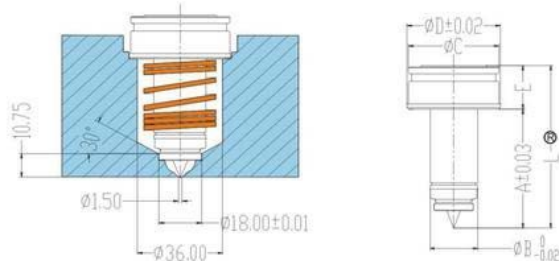
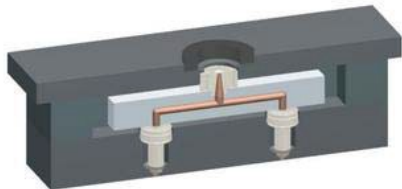

注：“R”为膨胀量 “R” referring heat expending rate

PMT- I -M	A	B	C	D	E	L	加热圈长度 Cold heater ϕ & length	功率 Power	铜套加热圈 Copper sleeve coil
PMT- I -M22-75	55	22	42	43	20	75	$\phi 22 \times 40$	380W	
PMT- I -M22-85	65	22	42	43	20	85	$\phi 22 \times 50$	420W	
PMT- I -M22-95	75	22	42	43	20	95	$\phi 22 \times 60$	500W	
PMT- I -M22-105	85	22	42	43	20	105	$\phi 22 \times 70$	570W	380W
PMT- I -M22-115	95	22	42	43	20	115	$\phi 22 \times 80$	650W	420W
PMT- I -M22-125	105	22	42	43	20	125	$\phi 22 \times 90$	760W	460W
PMT- I -M22-135	115	22	42	43	20	135	$\phi 22 \times 100$	840W	530W
PMT- I -M22-145	125	22	42	43	20	145	$\phi 22 \times 110$	840W	610W

*以上喷嘴加热圈功率在900W以下的，其直条截面尺寸是：X * Y = 4.2 * 2.2mm (X为宽度，Y为厚度)
 *以上喷嘴加热圈功率在900W以上的，根据喷嘴的要求，其直条截面尺寸另定。
 *以上喷嘴热电偶为J型。
 *以上参数若有改动，恕难及时通知。

*Above nozzle, the coiled heater diameter indication is meaning the inner diameter.
 *Above nozzle, the coiled heater power below 900W, the section dimension is 4.2x2.2mm (width x thickness). If the power over 900W, heater's section dimension will be same or subject to change.
 *Above nozzle, the thermocouple is J type.
 *Above parameter is subject to change without notice.

特点，优点：

- 杰出的设计，保证换色迅速，最大可能地减少热量散失。
 - 表面有针点痕迹的进料口。
 - 适用于高流动性塑料的成型。
 - 德国电加热元件和热电偶。
 - 德国进口钢料经过精湛的热处理和合理精确的加工工艺。
 - 经过4道尺寸和温控的严格检验。
- outstanding design guaranteed fast color changes & prevented heating transfer to the mould.
 -on the plastic parts surface, there is pin point mark.
 -suitable for high melting flow index material injection.
 -German origin heating elements and thermocouple.
 -German steel by correct harden treatment and precision tooling processing.
 -Each nozzle from the beginning until the well finished, there are 4 times dimension controlling and temperature controlling inspections

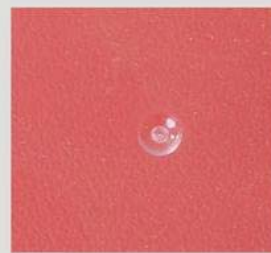

*用该喷嘴注塑成型后的浇口效果图

PMT- I -M

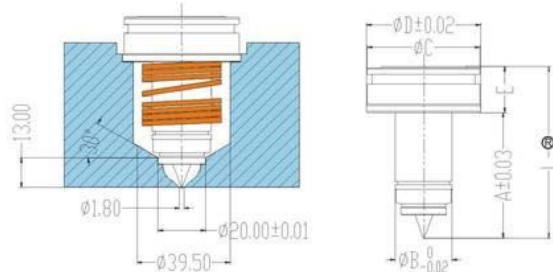
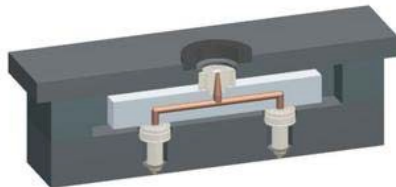

注：“R”为膨胀量 “R” referring heat expending rate

PMT- I -M	A	B	C	D	E	L	加热圈长度 Cold heater φ & length	功率 Power	铜套加热圈 Copper sleeve coil
PMT- I -M25-75	55	25	49	50	20	75	φ 25x35	420W	
PMT- I -M25-85	65	25	49	50	20	85	φ 25x45	500W	
PMT- I -M25-95	75	25	49	50	20	95	φ 25x55	570W	420W
PMT- I -M25-105	85	25	49	50	20	105	φ 25x65	650W	460W
PMT- I -M25-115	95	25	49	50	20	115	φ 25x75	760W	530W
PMT- I -M25-125	105	25	49	50	20	125	φ 25x85	840W	610W
PMT- I -M25-135	115	25	49	50	20	135	φ 25x95	840W	690W
PMT- I -M25-145	125	25	49	50	20	145	φ 25x105	840W	760W

*以上喷嘴加热圈功率在900W以下的，其直条截面尺寸是：X*Y=4.2*2.2mm（X为宽度，Y为厚度）
 *以上喷嘴加热圈功率在900W以上的，根据喷嘴的要求，其直条截面尺寸另定。
 *以上喷嘴热电偶为J型。
 *以上参数若有改动，恕难及时通知。

*Above nozzle, the coiled heater diameter indication is meaning the inner diameter.
 *Above nozzle, the coiled heater power below 900W, the section dimension is 4.2x2.2mm (width x thickness). If the power over 900W, heater's section dimension will be same or subject to change.
 *Above nozzle, the thermocouple is J type.
 *Above parameter is subject to change without notice.

特点，优点：

- 杰出的设计，保证换色迅速，最大可能地减少热量散失。
 - 表面有针点痕迹的进料口。
 - 适用于高流动性塑料的成型。
 - 德国电加热元件和热电偶。
 - 德国进口钢料经过精湛的热处理和合理精确的加工工艺。
 - 经过4道尺寸和温控的严格检验。
- outstanding design guaranteed fast color changements & prevented heating transfer to the mould
 -on the plastic parts surface, there is pin point mark.
 -suitable for high melting flow index material injection.
 -German origin heating elements and thermocouple.
 -German steel by correct harden treatment and precision tooling processing.
 -Each nozzle from the beginning until the well finished, there are 4 times dimension controlling and temperature controlling inspections



*用该喷嘴注塑成型后的浇口效果图

PST- I -L

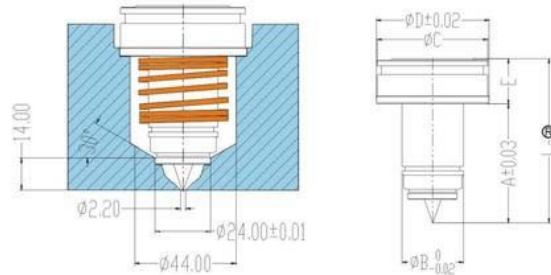
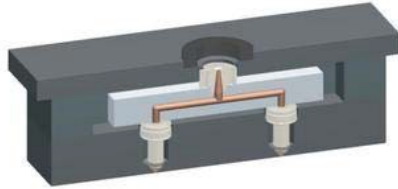

注：“R”为膨胀量 “R” referring heat expending rate

PST- I -L	A	B	C	D	E	L	加热圈长度 Coil heater ϕ & length	功率 Power
PST- I -L30-80	58	30	54	55	22	80	待定 to be determined	待定 to be determined
PST- I -L30-90	68	30	54	55	22	90		
PST- I -L30-100	78	30	54	55	22	100		
PST- I -L30-110	88	30	54	55	22	110		
PST- I -L30-120	98	30	54	55	22	120		
PST- I -L30-130	108	30	54	55	22	130		
PST- I -L30-140	118	30	54	55	22	140		
PST- I -L30-150	128	30	54	55	22	150		
PST- I -L30-160	138	30	54	55	22	160		
PST- I -L30-170	148	30	54	55	22	170		

*以上喷嘴加热圈功率在900W以下的，其直条截面尺寸是：X * Y=4.2*2.2mm (X为宽度，Y为厚度)
 *以上喷嘴加热圈功率在900W以上的，根据喷嘴的要求，其直条截面尺寸另定。
 *以上喷嘴热电偶为J型。
 *以上参数若有改动，恕难及时通知。

*Above nozzle, the coiled heater diameter indication is meaning the inner diameter.
 *Above nozzle, the coiled heater power below 900W, the section dimension is 4.2x2.2mm (width x thickness). If the power over 900W, heater's section dimension will be same or subject to change.
 *Above nozzle, the thermocouple is J type.
 *Above parameter is subject to change without notice.

特点，优点：

- 杰出的设计，保证换色迅速，最大可能地减少热量散失。
- 表面有针点痕迹的进料口。
- 适用于高流动性塑料的成型。
- 德国电加热元件和热电偶。
- 德国进口钢料经过精湛的热处理和合理精确的加工工艺。
- 经过4道尺寸和温控的严格检验。
- outstanding design guaranteed fast color change & prevented heating transfer to the mould.
- on the plastic parts surface, there is pin point mark.
- suitable for high melting flow index material injection.
- German origin heating elements and thermocouple.
- German steel by correct harden treatment and precision tooling processing.
- Each nozzle from the beginning until the well finished, there are 4 times dimension controlling and temperature controlling inspections



*用该喷嘴注塑成型后的浇口效果图

PMT- I -L

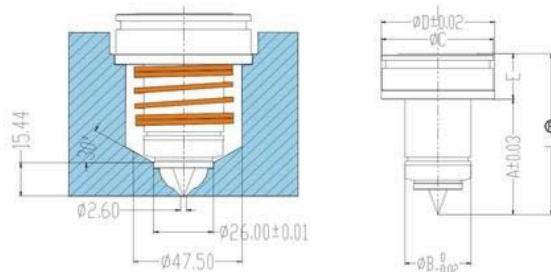
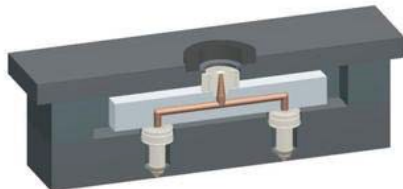

注：“R”为膨胀量 “R” referring heat expending rate

PMT- I -L	A	B	C	D	E	L	加热圈长度 Coil heater ϕ & length	功率 Power
PMT- I -L35-85	61	35	59	60	24	85	待定 to be determined	待定 to be determined
PMT- I -L35-95	71	35	59	60	24	95		
PMT- I -L35-105	81	35	59	60	24	105		
PMT- I -L35-115	91	35	59	60	24	115		
PMT- I -L35-125	101	35	59	60	24	125		
PMT- I -L35-135	111	35	59	60	24	135		
PMT- I -L35-145	121	35	59	60	24	145		
PMT- I -L35-155	131	35	59	60	24	155		
PMT- I -L35-165	141	35	59	60	24	165		
PMT- I -L35-175	151	35	59	60	24	175		

*以上喷嘴加热圈功率在900W以下的，其直条截面尺寸是：X * Y = 4.2 * 2.2mm (X为宽度，Y为厚度)
 *以上喷嘴加热圈功率在900W以上的，根据喷嘴的要求，其直条截面尺寸另定。
 *以上喷嘴热电偶为J型。
 *以上参数若有改动，恕难及时通知。

*Above nozzle, the coiled heater diameter indication is meaning the inner diameter.
 *Above nozzle, the coiled heater power below 900W, the section dimension is 4.2x2.2mm (width x thickness). If the power over 900W, heater's section dimension will be same or subject to change.
 *Above nozzle, the thermocouple is J type.
 *Above parameter is subject to change without notice.

特点，优点：

- 杰出的设计，保证换色迅速，最大可能地减少热量散失。
- 表面有针点痕迹的进料口。
- 适用于高流动性塑料的成型。
- 德国电加热元件和热电偶。
- 德国进口钢料经过精湛的热处理和合理精确的加工工艺。
- 经过4道尺寸和温控的严格检验。
- outstanding design guaranteed fast color changes & prevented heating transfer to the mould.
- on the plastic parts surface, there is pin point mark.
- suitable for high melting flow index material injection.
- German origin heating elements and thermocouple.
- German steel by correct harden treatment and precision tooling processing.
- Each nozzle from the beginning until the well finished, there are 4 times dimension controlling and temperature controlling inspections

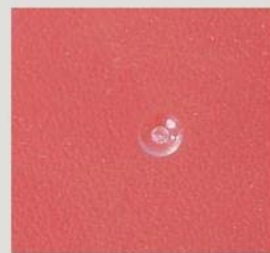

*用该喷嘴注塑成型后的浇口效果图

PMT-II-S

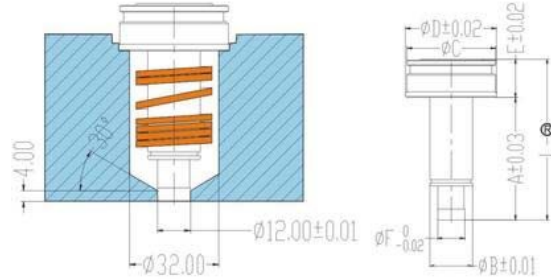
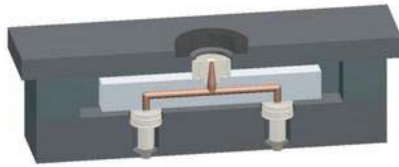

注：“R”为膨胀量 “R” referring heat expending rate

PMT-II-S	A	B	C	D	E	F	L	加热圈长度 Coil heater φ & length	功率 Power	铜套加热圈 Copper sleeve coil
PMT-II-S19-70	53	19	39	40	17	12	70	φ19x40	350W	
PMT-II-S19-80	63	19	39	40	17	12	80	φ19x50	420W	
PMT-II-S19-90	73	19	39	40	17	12	90	φ19x60	500W	
PMT-II-S19-100	83	19	39	40	17	12	100	φ19x70	530W	380W
PMT-II-S19-110	93	19	39	40	17	12	110	φ19x80	650W	420W
PMT-II-S19-120	103	19	39	40	17	12	120	φ19x90	760W	460W

*以上喷嘴加热圈功率在900W以下的，其直条截面尺寸是：X * Y = 4.2 * 2.2mm (X为宽度，Y为厚度)
 *以上喷嘴加热圈功率在900W以上的，根据喷嘴的要求，其直条截面尺寸另定。
 *以上喷嘴热电偶为J型。
 *以上参数若有改动，恕难及时通知。

*Above nozzle, the coiled heater diameter indication is meaning the inner diameter.
 *Above nozzle, the coiled heater power below 900W, the section dimension is 4.2x2.2mm (width x thickness). If the power over 900W, heater's section dimension will be same or subject to change.
 *Above nozzle, the thermocouple is J type.
 *Above parameter is subject to change without notice.

点浇口附注：

- 杰出的设计，保证换色迅速，最大可能地减少热量散失。
- 表面有针点痕迹的进料口。
- 适用于高流动性塑料的成型。
- 德国电加热元件和热电偶。
- 德国进口钢料经过精湛的热处理和合理精确的加工工艺。
- 经过4道尺寸和温控的严格检验。

- outstanding design guaranteed fast color changesments & prevented heating transfer to the mould
- on the plastic parts surface, there is pin point mark.
- suitable for high melting flow index material injection.
- German origin heating elements and thermocouple.
- German steel by correct harden treatment and precision tooling processing.
- Each nozzle from the beginning until the well finished, there are 4 times dimension controlling and temperature controlling inspections



*用该喷嘴注塑成型后的浇口效果图

PMT- II -M

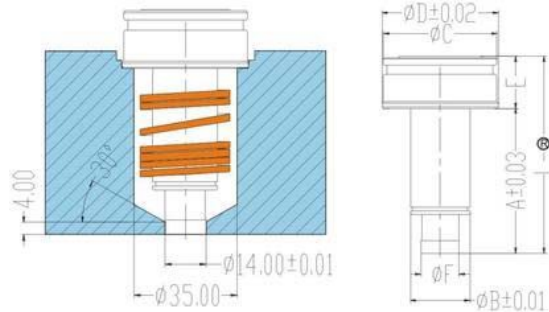
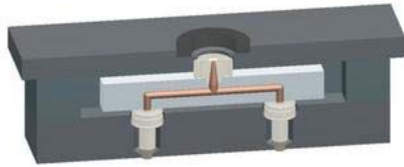

注：“R”为膨胀量 “R” referring heat expanding rate

PMT- II -M	A	B	C	D	E	F	L	加热圈长度 Coil heater & length	功率 Power	铜套加热圈 Copper sleeve coil
PMT- II -M22-70	50	22	42	43	20	14	70	φ22x40	380W	
PMT- II -M22-80	60	22	42	43	20	14	80	φ22x50	460W	
PMT- II -M22-90	70	22	42	43	20	14	90	φ22x60	530W	
PMT- II -M22-100	80	22	42	43	20	14	100	φ22x70	650W	420W
PMT- II -M22-110	90	22	42	43	20	14	110	φ22x80	760W	460W
PMT- II -M22-120	100	22	42	43	20	14	120	φ22x90	650W	500W
PMT- II -M22-130	110	22	42	43	20	14	130	φ22x100	840W	530W
PMT- II -M22-140	120	22	42	43	20	14	140	φ22x110	840W	610W

*以上喷嘴加热圈功率在900W以下的，其直条截面尺寸是：X * Y = 4.2 * 2.2mm (X为宽度，Y为厚度)

*以上喷嘴加热圈功率在900W以上的，根据喷嘴的要求，其直条截面尺寸另定。

*以上喷嘴热电偶为J型。

*以上参数若有改动，恕难及时通知。

*Above nozzle, the coiled heater diameter indication is meaning the inner diameter.

*Above nozzle, the coiled heater power below 900W, the section dimension is 4.2x2.2mm (width x thickness). If the power over 900W, heater's section dimension will be same or subject to change.

*Above nozzle, the thermocouple is J type.

*Above parameter is subject to change without notice.

点浇口附注：

- 杰出的设计，保证换色迅速，最大可能地减少热量散失。
- 表面有针点痕迹的进料口。
- 适用于高流动性塑料的成型。
- 德国电加热元件和热电偶。
- 德国进口钢料经过精湛的热处理和合理精确的加工工艺。
- 经过4道尺寸和温控的严格检验。

- outstanding design guaranteed fast color changes & prevented heating transfer to the mould.
- on the plastic parts surface, there is pin point mark.
- suitable for high melting flow index material injection.
- German origin heating elements and thermocouple.
- German steel by correct harden treatment and precision tooling processing.
- Each nozzle from the beginning until the well finished, there are 4 times dimension controlling and temperature controlling inspections.



*用该喷嘴注塑成型后的浇口效果图

PMT-II-L

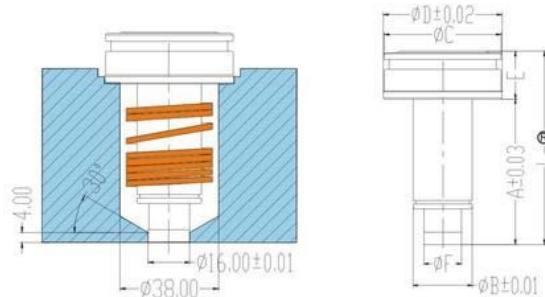
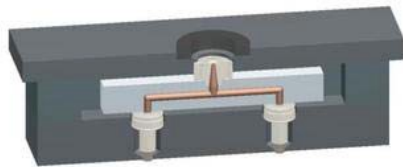

注：“R”为膨胀量 “R” referring heat expending rate

PMT-II-L	A	B	C	D	E	F	L	加热圈长度 Coil heater ϕ & length	功率 Power	铜套加热圈 Copper sleeve coil
PMT-II-L25-75	55	25	49	50	20	16	75	$\phi 25 \times 42$	460W	
PMT-II-L25-85	65	25	49	50	20	16	85	$\phi 25 \times 52$	500W	
PMT-II-L25-95	75	25	49	50	20	16	95	$\phi 25 \times 62$	610W	380W
PMT-II-L25-105	85	25	49	50	20	16	105	$\phi 25 \times 72$	650W	420W
PMT-II-L25-115	95	25	49	50	20	16	115	$\phi 25 \times 82$	690W	460W
PMT-II-L25-125	105	25	49	50	20	16	125	$\phi 25 \times 92$	760W	610W
PMT-II-L25-135	115	25	49	50	20	16	135	$\phi 25 \times 102$	840W	570W
PMT-II-L25-145	125	25	49	50	20	16	145	$\phi 25 \times 112$	840W	650W

*以上喷嘴加热圈功率在900W以下的，其直条截面尺寸是：X * Y = 4.2 * 2.2mm (X为宽度，Y为厚度)
 *以上喷嘴加热圈功率在900W以上的，根据喷嘴的要求，其直条截面尺寸另定。
 *以上喷嘴热电偶为J型。
 *以上参数若有改动，恕难及时通知。

*Above nozzle, the coiled heater diameter indication is meaning the inner diameter.
 *Above nozzle, the coiled heater power below 900W, the section dimension is 4.2x2.2mm (width x thickness). If the power over 900W, heater's section dimension will be same or subject to change.
 *Above nozzle, the thermocouple is J type.
 *Above parameter is subject to change without notice.

点浇口附注：

- 杰出的设计，保证换色迅速，最大可能地减少热量散失。
- 表面有针点痕迹的进料口。
- 适用于高流动性塑料的成型。
- 德国电加热元件和热电偶。
- 德国进口钢料经过精湛的热处理和合理精确的加工工艺。
- 经过4道尺寸和温控的严格检验。

- outstanding design guaranteed fast color changesments & prevented heating transfer to the mould.
- on the plastic parts surface, there is pin point mark.
- suitable for high melting flow index material injection.
- German origin heating elements and thermocouple.
- German steel by correct harden treatment and precision tooling processing.
- Each nozzle by the begining until the well finished, there are 4 times dimension controlling and temperature controlling inspections.



*用该喷嘴注塑成型后的浇口效果图

STHSB-S

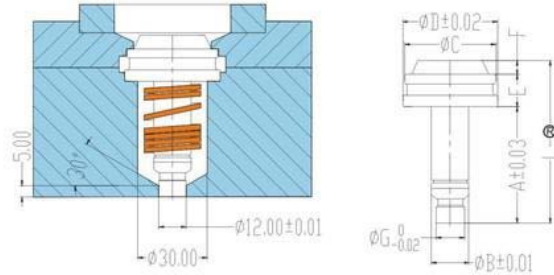
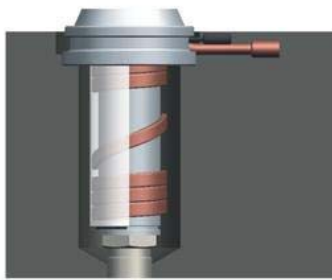

注：“R”为膨胀量 “R” referring heat expanding rate

STHSB-S	A	B	C	D	E	F	G	L	加热圈长度 Coil heater & length	功率 Power
STSHB-S16-70	50	16	39.4	41	14	6	12	70	$\phi 16 \times 35$	300W
STSHB-S16-75	55	16	39.4	41	14	6	12	75	$\phi 16 \times 40$	350W
STSHB-S16-85	65	16	39.4	41	14	6	12	85	$\phi 16 \times 50$	420W
STSHB-S16-95	75	16	39.4	41	14	6	12	95	$\phi 16 \times 60$	500W
STSHB-S16-105	85	16	39.4	41	14	6	12	105	$\phi 16 \times 70$	570W
STSHB-S16-115	95	16	39.4	41	14	6	12	115	$\phi 16 \times 80$	650W

*以上喷嘴加热圈功率在900W以下的，其直条截面尺寸是：X * Y = 4.2 * 2.2mm (X为宽度，Y为厚度)
 *以上喷嘴加热圈功率在900W以上的，根据喷嘴的要求，其直条截面尺寸另定。
 *以上喷嘴热电偶为J型。
 *以上参数若有改动，恕难及时通知。

*Above nozzle, the coiled heater diameter indication is meaning the inner diameter.
 *Above nozzle, the coiled heater power below 900W, the section dimension is 4.2x2.2mm (width x thickness). If the power over 900W, heater's section dimension will be same or subject to change.
 *Above nozzle, the thermocouple is J type.
 *Above parameter is subject to change without notice.

特点，优点：

- 高流量设计，适合大面积，大体积注射。
- 换色迅速。
- 适合表面允许有料把的塑料产品。
- 适用于普通材料和工程塑料的成型。
- 适用于磨损性与含有填料的塑料成型。
- 德国电加热元件和热电偶。
- 德国进口钢料经过精湛的的热处理和合理精确的加工工艺。
- 经过4道尺寸和温控的严格检验。

- suitable for big surface and big volume injection.
- excellent color change performance.
- suitable for the plastic parts which allow the gate tails on it.
- suitable for normal & engineering plastic raw material injection.
- suitable for durable, hard plastic material & Glass Fiber added plastic material injection.
- German origin heating elements and thermocouple.
- German steel by correct harden treatment and precision tooling processing.
- Each nozzle from the beginning until the well finished, there are 4 times dimension controlling and temperature controlling inspections.



*用该喷嘴注塑成型后的浇口效果图

STHSB-S

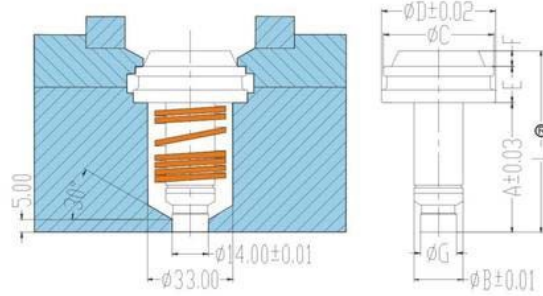
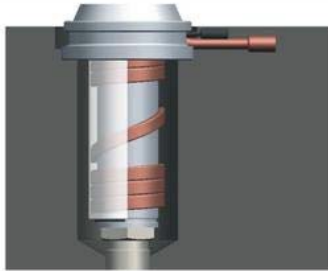

注：“R”为膨胀量 “R” referring heat expending rate

STHSB-S	A	B	C	D	E	F	G	L	加热圈长度 Coil heater & length	功率 Power	铜套加热圈 Copper sleeve coil
STSHB-S19-70	50	19	42.4	44	14	6	14	70	Φ 19x40	380W	
STSHB-S19-80	60	19	42.4	44	14	6	14	80	Φ 19x50	460W	
STSHB-S19-90	70	19	42.4	44	14	6	14	90	Φ 19x60	530W	
STSHB-S19-100	80	19	42.4	44	14	6	14	100	Φ 19x70	610W	420W
STSHB-S19-110	90	19	42.4	44	14	6	14	110	Φ 19x80	690W	460W
STSHB-S19-120	100	19	42.4	44	14	6	14	120	Φ 19x90	760W	610W

*以上喷嘴加热圈功率在900W以下的，其直条截面尺寸是：X * Y = 4.2 * 2.2mm (X为宽度，Y为厚度)

*以上喷嘴加热圈功率在900W以上的，根据喷嘴的要求，其直条截面尺寸另定。

*以上喷嘴热电偶为J型。

*以上参数若有改动，恕难及时通知。

*Above nozzle, the coiled heater diameter indication is meaning the inner diameter.

*Above nozzle, the coiled heater power below 900W, the section dimension is 4.2x2.2mm (width x thickness). If the power over 900W, heater's section dimension will be same or subject to change.

*Above nozzle, the thermocouple is J type.

*Above parameter is subject to change without notice.

特点，优点：

- 高流量设计，适合大面积，大体积注射。
- 换色迅速。
- 适合表面允许有料把的塑料产品。
- 适用于普通材料和工程塑料的成型。
- 适用于磨损性与含有填料的塑料成型。
- 德国电加热元件和热电偶。
- 德国进口钢料经过精湛的热处理和合理精确的加工工艺。
- 经过4道尺寸和温控的严格检验。
- suitable for big surface and big volume injection.
- excellent color change performance.
- suitable for the plastic parts which allow the gate tails on it.
- suitable for normal & engineering plastic raw material injection.
- suitable for durable, hard plastic material & Glass Fiber added plastic material injection.
- German origin heating elements and thermocouple.
- German steel by correct harden treatment and precision tooling processing.
- Each nozzle from the beginning until the well finished, there are 4 times dimension controlling and temperature controlling inspections.



*用该喷嘴注塑成型后的浇口效果图

STHSB-M

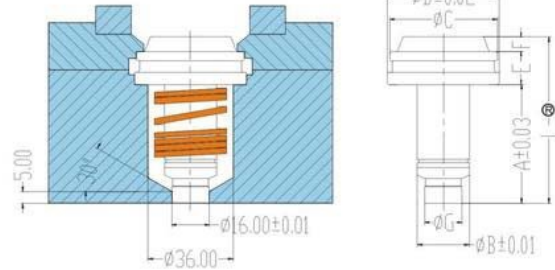
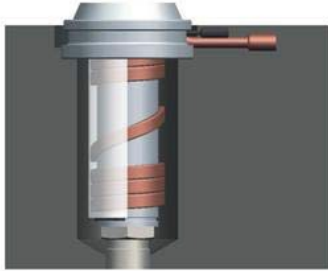

注：“R”为膨胀量 “R” referring heat expending rate

STHSB-M	A	B	C	D	E	F	G	L	加热圈长度 Coil heater ϕ & length	功率 Power	铜套加热圈 Copper sleeve coil
STHSB-M22-70	50	22	45.4	47	14	6	16	70	$\phi 22 \times 40$	420W	
STHSB-M22-80	60	22	45.4	47	14	6	16	80	$\phi 22 \times 50$	460W	
STHSB-M22-90	70	22	45.4	47	14	6	16	90	$\phi 22 \times 60$	570W	
STHSB-M22-100	80	22	45.4	47	14	6	16	100	$\phi 22 \times 70$	650W	460W
STHSB-M22-110	90	22	45.4	47	14	6	16	110	$\phi 22 \times 80$	760W	500W
STHSB-M22-120	100	22	45.4	47	14	6	16	120	$\phi 22 \times 90$	840W	530W
STHSB-M22-130	110	22	45.4	47	14	6	16	130	$\phi 22 \times 100$	840W	570W
STHSB-M22-140	120	22	45.4	47	14	6	16	140	$\phi 22 \times 110$	840W	650W

*以上喷嘴加热圈功率在900W以下的，其直条截面尺寸是：X*Y=4.2*2.2mm（X为宽度，Y为厚度）
*以上喷嘴加热圈功率在900W以上的，根据喷嘴的要求，其直条截面尺寸另定。

*以上喷嘴热电偶为J型。

*以上参数若有改动，恕难及时通知。

*Above nozzle, the coiled heater diameter indication is meaning the inner diameter.

*Above nozzle, the coiled heater power below 900W, the section dimension is 4.2x2.2mm (width x thickness). If the power over 900W, heater's section dimension will be same or subject to change.

*Above nozzle, the thermocouple is J type.

*Above parameter is subject to change without notice.

特点，优点：

- 高流量设计，适合大面积，大体积注射。
- 换色迅速。
- 适合表面允许有料把的塑料产品。
- 适用于普通材料和工程塑料的成型。
- 适用于磨损性与含有填料的塑料成型。
- 德国电加热元件和热电偶。
- 德国进口钢料经过精湛的热处理和合理精确的加工工艺。
- 经过4道尺寸和温控的严格检验。

- suitable for big surface and big volume injection.
- excellent color change performance.
- suitable for the plastic parts which allow the gate tails on it.
- suitable for normal & engineering plastic raw material injection.
- suitable for durable, hard plastic material & Glass Fiber added plastic material injection.
- German origin heating elements and thermocouple.
- German steel by correct harden treatment and precision tooling processing.
- Each nozzle from the beginning until the well finished, there are 4 times dimension controlling and temperature controlling inspections.



*用该喷嘴注塑成型后的浇口效果图

STHSB-M

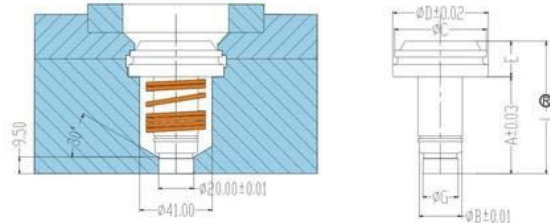
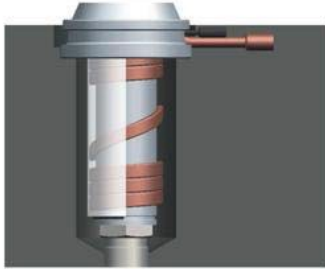

注：“R”为膨胀量 “R” referring heat expanding rate

STHSB-M	A	B	C	D	E	F	G	L	加热圈长度 Coil heater ϕ & length	功率 Power	铜套加热圈 Copper sleeve coil
STHSB-M25-75	55	25	52	54	15	5	20	75	ϕ 25x35	420W	
STHSB-M25-85	65	25	52	54	15	5	20	85	ϕ 25x45	460W	
STHSB-M25-95	75	25	52	54	15	5	20	95	ϕ 25x55	570W	420W
STHSB-M25-105	85	25	52	54	15	5	20	105	ϕ 25x65	650W	460W
STHSB-M25-115	95	25	52	54	15	5	20	115	ϕ 25x75	760W	530W
STHSB-M25-125	105	25	52	54	15	5	20	125	ϕ 25x85	840W	610W
STHSB-M25-135	115	25	52	54	15	5	20	135	ϕ 25x95	840W	690W
STHSB-M25-145	125	25	52	54	15	5	20	145	ϕ 25x105	840W	760W

- *以上喷嘴加热圈功率在900W以下的，其直条截面尺寸是：X * Y = 4.2 * 2.2mm (X为宽度，Y为厚度)
- *以上喷嘴加热圈功率在900W以上的，根据喷嘴的要求，其直条截面尺寸另定。
- *以上喷嘴热电偶为J型。
- *以上参数若有改动，恕难及时通知。

- *Above nozzle, the coiled heater diameter indication is meaning the inner diameter.
- *Above nozzle, the coiled heater power below 900W, the section dimension is 4.2x2.2mm (width x thickness). If the power over 900W, heater's section dimension will be same or subject to change.
- *Above nozzle, the thermocouple is J type.
- *Above parameter is subject to change without notice.

特点，优点：

- 高流量设计，适合大面积，大体积注射。
- 换色迅速。
- 适合表面允许有料把的塑料产品。
- 适用于普通材料和工程塑料的成型。
- 适用于磨损性与含有填料的塑料成型。
- 德国电加热元件和热电偶。
- 德国进口钢料经过精湛的热处理和合理精确的加工工艺。
- 经过4道尺寸和温控的严格检验。
- suitable for big surface and big volume injection.
- excellent color change performance.
- suitable for the plastic parts which allow the gate tails on it.
- suitable for normal & engineering plastic raw material injection.
- suitable for durable, hard plastic material & Glass Fiber added plastic material injection.
- German origin heating elements and thermocouple.
- German steel by correct harden treatment and precision tooling processing.
- Each nozzle from the beginning until the well finished, there are 4 times dimension controlling and temperature controlling inspections.



*用该喷嘴注塑成型后的浇口效果图

STHSB-L

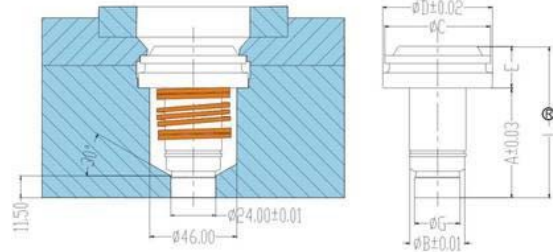
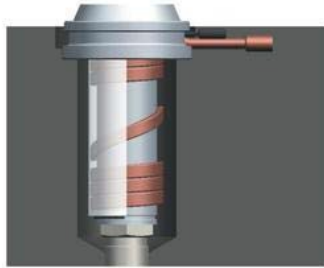

STHSB-L	A	B	C	D	E	F	G	L	加热圈长度 Coil heater ϕ & length	功率 Power
STHSB-L30-80	58	30	56	58	17	5	24	80	待定 to be determined	待定 to be determined
STHSB-L30-90	68	30	56	58	17	5	24	90		
STHSB-L30-100	78	30	56	58	17	5	24	100		
STHSB-L30-110	88	30	56	58	17	5	24	110		
STHSB-L30-120	98	30	56	58	17	5	24	120		
STHSB-L30-130	108	30	56	58	17	5	24	130		
STHSB-L30-140	118	30	56	58	17	5	24	140		
STHSB-L30-150	128	30	56	58	17	5	24	150		
STHSB-L30-160	138	30	56	58	17	5	24	160		
STHSB-L30-170	148	30	56	58	17	5	24	170		

*以上喷嘴加热圈功率在900W以下的，其直条截面尺寸是：X * Y = 4.2 * 2.2mm (X为宽度，Y为厚度)
 *以上喷嘴加热圈功率在900W以上的，根据喷嘴的要求，其直条截面尺寸另定。
 *以上喷嘴热电偶为J型。
 *以上参数若有改动，恕难及时通知。

*Above nozzle, the coiled heater diameter indication is meaning the inner diameter.
 *Above nozzle, the coiled heater power below 900W, the section dimension is 4.2x2.2mm (width x thickness). If the power over 900W, heater's section dimension will be same or subject to change.
 *Above nozzle, the thermocouple is J type.
 *Above parameter is subject to change without notice.

特点，优点：

- 高流量设计，适合大面积，大体积注射。
- 换色迅速。
- 适合表面允许有料把的塑料产品。
- 适用于普通材料和工程塑料的成型。
- 适用于磨损性与含有填料的塑料成型。
- 德国电加热元件和热电偶。
- 德国进口钢料经过精湛的热处理和合理精确的加工工艺。
- 经过4道尺寸和温控的严格检验。
- suitable for big surface and big volume injection.
- excellent color change performance.
- suitable for the plastic parts which allow the gate tails on it.
- suitable for normal & engineering plastic raw material injection.
- suitable for durable, hard plastic material & Glass Fiber added plastic material injection.
- German origin heating elements and thermocouple.
- German steel by correct harden treatment and precision tooling processing.
- Each nozzle from the beginning until the well finished, there are 4 times dimension controlling and temperature controlling inspections.



*用该喷嘴注塑成型后的浇口效果图

STHSB-L

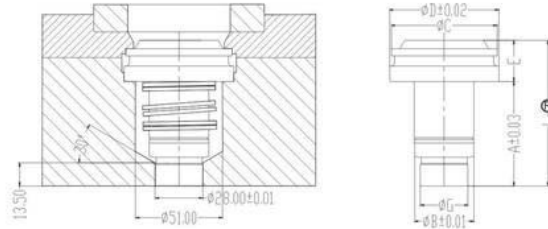
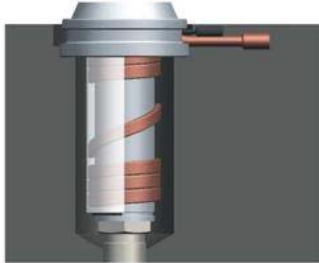

注：“R”为膨胀量 “R” referring heat expending rate

STHSB-L	A	B	C	D	E	F	G	L	加热圈长度 Coil heater ϕ & length	功率 Power
STHSB-L35-85	61	35	62	64	19	5	28	85	待定 to be determined	待定 to be determined
STHSB-L35-95	71	35	62	64	19	5	28	95		
STHSB-L35-105	81	35	62	64	19	5	28	105		
STHSB-L35-115	91	35	62	64	19	5	28	115		
STHSB-L35-125	101	35	62	64	19	5	28	125		
STHSB-L35-135	111	35	62	64	19	5	28	135		
STHSB-L35-145	121	35	62	64	19	5	28	145		
STHSB-L35-155	131	35	62	64	19	5	28	155		
STHSB-L35-165	141	35	62	64	19	5	28	165		
STHSB-L35-175	151	35	62	64	19	5	28	175		

- *以上喷嘴加热圈功率在900W以下的，其直条截面尺寸是：X * Y = 4.2 * 2.2mm (X为宽度，Y为厚度)
- *以上喷嘴加热圈功率在900W以上的，根据喷嘴的要求，其直条截面尺寸另定。
- *以上喷嘴热电偶为J型。
- *以上参数若有改动，恕难及时通知。

- *Above nozzle, the coiled heater diameter indication is meaning the inner diameter.
- *Above nozzle, the coiled heater power below 900W, the section dimension is 4.2x2.2mm (width x thickness). If the power over 900W, heater's section dimension will be same or subject to change.
- *Above nozzle, the thermocouple is J type.
- *Above parameter is subject to change without notice.

特点，优点：

- 高流量设计，适合大面积，大体积注射。
- 换色迅速。
- 适合表面允许有料把的塑料产品。
- 适用于普通材料和工程塑料的成型。
- 适用于磨损性与含有填料的塑料成型。
- 德国电加热元件和热电偶。
- 德国进口钢料经过精湛的热处理和合理精确的加工工艺。
- 经过4道尺寸和温控的严格检验。
- suitable for big surface and big volume injection.
- excellent color change performance.
- suitable for the plastic parts which allow the gate tails on it.
- suitable for normal & engineering plastic raw material injection.
- suitable for durable, hard plastic material & Glass Fiber added plastic material injection.
- German origin heating elements and thermocouple.
- German steel by correct harden treatment and precision tooling processing.
- Each nozzle from the beginning until the well finished, there are 4 times dimension controlling and temperature controlling inspections.

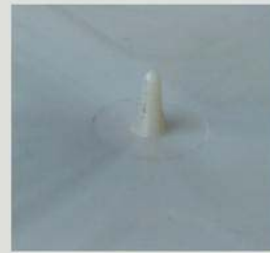

*用该喷嘴注塑成型后的浇口效果图

STHSB- I -M

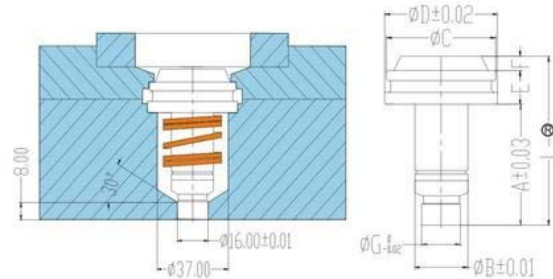
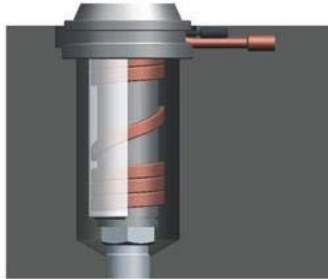

注：“R”为膨胀量 “R” referring heat expending rate

STHSB- I -M	A	B	C	D	E	F	G	L	加热圈长度 Coil heater ϕ & length	功率 Power	铜套加热圈 Copper sleeve coil
STHSB- I -M22-70	50	22	45.4	47	14	6	16	70	$\phi 22 \times 40$	420W	
STHSB- I -M22-80	60	22	45.4	47	14	6	16	80	$\phi 22 \times 50$	460W	
STHSB- I -M22-90	70	22	45.4	47	14	6	16	90	$\phi 22 \times 60$	570W	
STHSB- I -M22-100	80	22	45.4	47	14	6	16	100	$\phi 22 \times 70$	650W	460W
STHSB- I -M22-110	90	22	45.4	47	14	6	16	110	$\phi 22 \times 80$	760W	500W
STHSB- I -M22-120	100	22	45.4	47	14	6	16	120	$\phi 22 \times 90$	840W	530W
STHSB- I -M22-130	110	22	45.4	47	14	6	16	130	$\phi 22 \times 100$	840W	570W
STHSB- I -M22-140	120	22	45.4	47	14	6	16	140	$\phi 22 \times 110$	840W	650W

*以上喷嘴加热圈功率在900W以下的，其直条截面尺寸是：X * Y = 4.2 * 2.2mm (X为宽度，Y为厚度)
 *以上喷嘴加热圈功率在900W以上的，根据喷嘴的要求，其直条截面尺寸另定。
 *以上喷嘴热电偶为J型。
 *以上参数若有改动，恐难及时通知。

*Above nozzle, the coiled heater diameter indication is meaning the inner diameter.
 *Above nozzle, the coiled heater power below 900W, the section dimension is 4.2x2.2mm (width x thickness). If the power over 900W, heater's section dimension will be same or subject to change.
 *Above nozzle, the thermocouple is J type.
 *Above parameter is subject to change without notice.

特点，优点：

- 杰出的设计，保证换色迅速，最大可能地减少热量散失。
- 表面有针点痕迹的进料口。
- 适用于高流动性塑料的成型。
- 德国电加热元件和热电偶。
- 德国进口钢料经过精湛的热处理和合理精确的加工工艺。
- 经过4道尺寸和温控的严格检验。
- outstanding design guaranteed fast color changes & prevented heating transfer to the mould.
- on the plastic parts surface, there is pin point mark.
- suitable for high melting flow index material injection.
- German origin heating elements and thermocouple.
- German steel by correct harden treatment and precision tooling processing.
- Each nozzle from the beginning until the well finished, there are 4 times dimension controlling and temperature controlling inspections.



*用该喷嘴注塑成型后的浇口效果图

STHSB- I -M

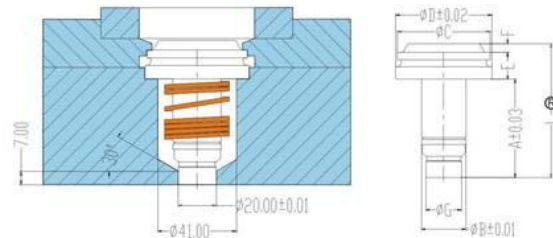
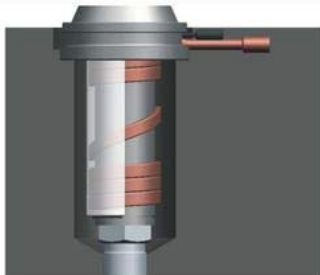

注：“R”为膨胀量 “R” referring heat expending rate

STHSB- I -M	A	B	C	D	E	F	G	L	加热圈长度 Coil heater & length	功率 Power	铜套加热圈 Copper sleeve coil
STHSB- I -M25-75	55	25	52	54	15	5	20	75	$\phi 25 \times 35$	420W	
STHSB- I -M25-85	65	25	52	54	15	5	20	85	$\phi 25 \times 45$	500W	
STHSB- I -M25-95	75	25	52	54	15	5	20	95	$\phi 25 \times 55$	570W	420W
STHSB- I -M25-105	85	25	52	54	15	5	20	105	$\phi 25 \times 65$	650W	460W
STHSB- I -M25-115	95	25	52	54	15	5	20	115	$\phi 25 \times 75$	760W	530W
STHSB- I -M25-125	105	25	52	54	15	5	20	125	$\phi 25 \times 85$	840W	610W
STHSB- I -M25-135	115	25	52	54	15	5	20	135	$\phi 25 \times 95$	840W	690W
STHSB- I -M25-145	125	25	52	54	15	5	20	145	$\phi 25 \times 105$	840W	760W

*以上喷嘴加热圈功率在900W以下的，其直条截面尺寸是：X*Y=4.2*2.2mm（X为宽度，Y为厚度）

*以上喷嘴加热圈功率在900W以上的，根据喷嘴的要求，其直条截面尺寸另定。

*以上喷嘴热电偶为J型。

*以上参数若有改动，恕难及时通知。

*Above nozzle, the coiled heater diameter indication is meaning the inner diameter.

*Above nozzle, the coiled heater power below 900W, the section dimension is 4.2x2.2mm (width x thickness). If the power over 900W, heater's section dimension will be same or subject to change.

*Above nozzle, the thermocouple is J type.

*Above parameter is subject to change without notice.

特点，优点：

- 杰出的设计，保证换色迅速，最大可能地减少热量散失。
- 表面有针点痕迹的进料口。
- 适用于高流动性塑料的成型。
- 德国电加热元件和热电偶。
- 德国进口钢料经过精湛的热处理和合理精确的加工工艺。
- 经过4道尺寸和温控的严格检验。

- outstanding design guaranteed fast color changements & prevented heating transfer to the mould
- on the plastic parts surface, there is pin point mark.
- suitable for high melting flow index material injection.
- German origin heating elements and thermocouple.
- German steel by correct harden treatment and precision tooling processing.
- Each nozzle from the beginning until the well finished, there are 4 times dimension controlling and temperature controlling inspections



*用该喷嘴注塑成型后的浇口效果图

STHSB- I -L

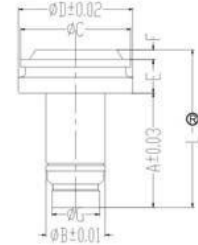
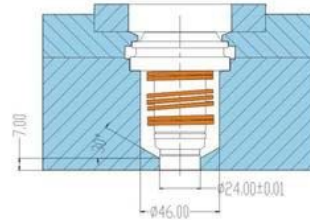
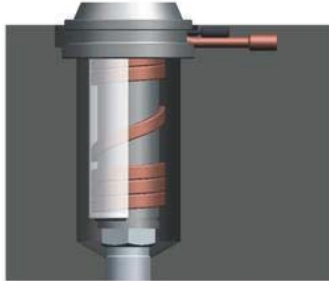

注：“R”为膨胀量 “R” referring heat expending rate

STHSB- I -L	A	B	C	D	E	F	G	L	加热圈长度 Coil heater ϕ & length	功率 Power
STHSB- I -L30-80	58	30	56	58	17	5	24	80	待定 to be determined	待定 to be determined
STHSB- I -L30-90	68	30	56	58	17	5	24	90		
STHSB- I -L30-100	78	30	56	58	17	5	24	100		
STHSB- I -L30-110	88	30	56	58	17	5	24	110		
STHSB- I -L30-120	98	30	56	58	17	5	24	120		
STHSB- I -L30-130	108	30	56	58	17	5	24	130		
STHSB- I -L30-140	118	30	56	58	17	5	24	140		
STHSB- I -L30-150	128	30	56	58	17	5	24	150		
STHSB- I -L30-160	138	30	56	58	17	5	24	160		
STHSB- I -L30-170	148	30	56	58	17	5	24	170		

*以上喷嘴加热圈功率在900W以下的，其直条截面尺寸是：X * Y = 4.2 * 2.2mm (X为宽度，Y为厚度)
 *以上喷嘴加热圈功率在900W以上的，根据喷嘴的要求，其直条截面尺寸另定。
 *以上喷嘴热电偶为J型。
 *以上参数若有改动，恕难及时通知。

*Above nozzle, the coiled heater diameter indication is meaning the inner diameter.
 *Above nozzle, the coiled heater power below 900W, the section dimension is 4.2x2.2mm (width x thickness). If the power over 900W, heater's section dimension will be same or subject to change.
 *Above nozzle, the thermocouple is J type.
 *Above parameter is subject to change without notice.

特点，优点：

- 杰出的设计，保证换色迅速，最大可能地减少热量散失。
- 表面有针点痕迹的进料口。
- 适用于高流动性塑料的成型。
- 德国电加热元件和热电偶。
- 德国进口钢料经过精湛的热处理和合理精确的加工工艺。
- 经过4道尺寸和温控的严格检验。
- outstanding design guaranteed fast color changes & prevented heating transfer to the mould.
- on the plastic parts surface, there is pin point mark.
- suitable for high melting flow index material injection.
- German origin heating elements and thermocouple.
- German steel by correct harden treatment and precision tooling processing.
- Each nozzle from the beginning until the well finished, there are 4 times dimension controlling and temperature controlling inspections



*用该喷嘴注塑成型后的浇口效果图

STHSB- I -L

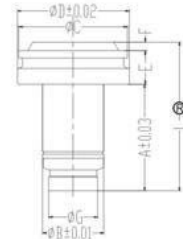
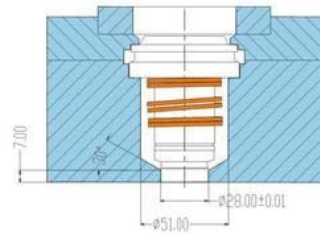
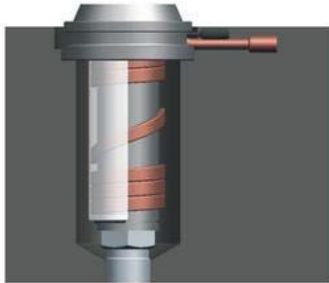

注：“R”为膨胀量 “R” referring heat expending rate

STHSB- I -L	A	B	C	D	E	F	G	L	加热圈长度 Coil heater φ& length	功率 Power
STHSB- I -L35-85	61	35	62	64	19	5	28	85	待定 to be determined	待定 to be determined
STHSB- I -L35-95	71	35	62	64	19	5	28	95		
STHSB- I -L35-105	81	35	62	64	19	5	28	105		
STHSB- I -L35-115	91	35	62	64	19	5	28	115		
STHSB- I -L35-125	101	35	62	64	19	5	28	125		
STHSB- I -L35-135	111	35	62	64	19	5	28	135		
STHSB- I -L35-145	121	35	62	64	19	5	28	145		
STHSB- I -L35-155	131	35	62	64	19	5	28	155		
STHSB- I -L35-165	141	35	62	64	19	5	28	165		
STHSB- I -L35-175	151	35	62	64	19	5	28	175		

*以上喷嘴加热圈功率在900W以下的，其直条截面尺寸是：X * Y=4.2*2.2mm（X为宽度，Y为厚度）

*以上喷嘴加热圈功率在900W以上的，根据喷嘴的要求，其直条截面尺寸另定。

*以上喷嘴热电偶为J型。

*以上参数若有改动，恕难及时通知。

*Above nozzle, the coiled heater diameter indication is meaning the inner diameter.

*Above nozzle, the coiled heater power below 900W, the section dimension is 4.2x2.2mm (width x thickness). If the power over 900W, heater's section dimension will be same or subject to change.

*Above nozzle, the thermocouple is J type.

*Above parameter is subject to change without notice.

特点，优点：

- 杰出的设计，保证换色迅速，最大可能地减少热量散失。
- 表面有针点痕迹的进料口。
- 适用于高流动性塑料的成型。
- 德国电加热元件和热电偶。
- 德国进口钢料经过精湛的热处理和合理精确的加工工艺。
- 经过4道尺寸和温控的严格检验。

-outstanding design guaranteed fast color changes & prevented heating transfer to the mould

-on the plastic parts surface, there is pin point mark.

-suitable for high melting flow index material injection.

-German origin heating elements and thermocouple.

-German steel by correct harden treatment and precision tooling processing.

-Each nozzle from the beginning until the well finished, there are 4 times dimension controlling and temperature controlling inspections



*用该喷嘴注塑成型后的浇口效果图

MTHSB-S

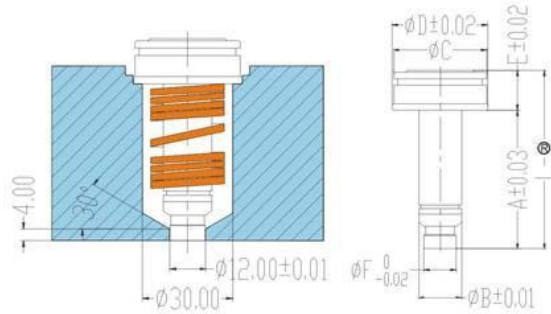
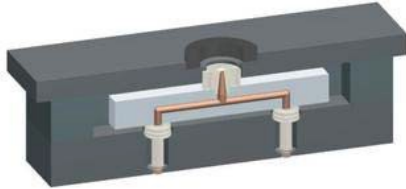

注：“R”为膨胀量 “R” referring heat expending rate

MTHSB-S	A	B	C	D	E	F	L	加热圈长度 Coil heater ϕ & length	功率 Power
MTHSB-S16-70	55	16	35	36	15	12	70	ϕ 16x40	350W
MTHSB-S16-80	65	16	35	36	15	12	80	ϕ 16x50	420W
MTHSB-S16-90	75	16	35	36	15	12	90	ϕ 16x60	500W
MTHSB-S16-100	85	16	35	36	15	12	100	ϕ 16x70	530W
MTHSB-S16-110	95	16	35	36	15	12	110	ϕ 16x80	570W
MTHSB-S16-120	105	16	35	36	15	12	120	ϕ 16x90	650W

*以上喷嘴加热圈功率在900W以下的，其直条截面尺寸是：X * Y = 4.2 * 2.2mm (X为宽度，Y为厚度)
 *以上喷嘴加热圈功率在900W以上的，根据喷嘴的要求，其直条截面尺寸另定。
 *以上喷嘴热电偶为J型。
 *以上参数若有改动，恕难及时通知。

*Above nozzle, the coiled heater diameter indication is meaning the inner diameter.
 *Above nozzle, the coiled heater power below 900W, the section dimension is 4.2x2.2mm (width x thickness). If the power over 900W, heater's section dimension will be same or subject to change.
 *Above nozzle, the thermocouple is J type.
 *Above parameter is subject to change without notice.

特点，优点：

- 高流量设计，适合大面积，大体积注射。
- 换色迅速。
- 适合表面允许有料把的塑料产品。
- 适用于普通材料和工程塑料的成型。
- 适用于磨损性与含有填料的塑料成型。
- 德国电加热元件和热电偶。
- 德国进口钢料经过精湛的热处理和合理精确的加工工艺。
- 经过4道尺寸和温控的严格检验。
- suitable for big surface and big volume injection.
- excellent color change performance.
- suitable for the plastic parts which allow the gate tails on it.
- suitable for normal & engineering plastic raw material injection.
- suitable for durable, hard plastic material & Glass Fiber added plastic material injection.
- German origin heating elements and thermocouple.
- German steel by correct harden treatment and precision tooling processing.
- Each nozzle from the beginning until the well finished, there are 4 times dimension controlling and temperature controlling inspections.

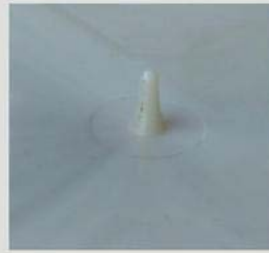

*用该喷嘴注塑成型后的浇口效果图

MTHSB-S

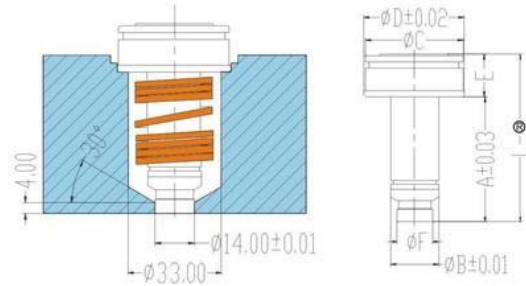
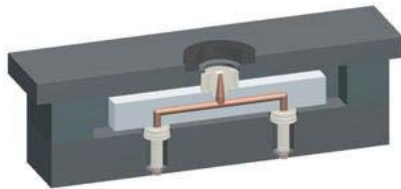

注：“R”为膨胀量 “R” referring heat expending rate

MTHSB-S	A	B	C	D	E	F	L	加热圈长度 Coil heater ϕ & length	功率 Power	铜套加热圈 Copper sleeve coil
MTHSB-S19-68	51	19	39	40	17	14	68	$\phi 19 \times 38$	350W	
MTHSB-S19-75	58	19	39	40	17	14	75	$\phi 19 \times 45$	380W	
MTHSB-S19-85	68	19	39	40	17	14	85	$\phi 19 \times 55$	420W	
MTHSB-S19-95	78	19	39	40	17	14	95	$\phi 19 \times 65$	500W	380W
MTHSB-S19-105	88	19	39	40	17	14	105	$\phi 19 \times 75$	610W	420W
MTHSB-S19-115	98	19	39	40	17	14	115	$\phi 19 \times 85$	650W	460W

*以上喷嘴加热圈功率在900W以下的，其直条截面尺寸是：X * Y = 4.2 * 2.2mm (X为宽度，Y为厚度)
 *以上喷嘴加热圈功率在900W以上的，根据喷嘴的要求，其直条截面尺寸另定。
 *以上喷嘴热电偶为J型。
 *以上参数若有改动，恕难及时通知。

*Above nozzle, the coiled heater diameter indication is meaning the inner diameter.
 *Above nozzle, the coiled heater power below 900W, the section dimension is 4.2x2.2mm (width x thickness). If the power over 900W, heater's section dimension will be same or subject to change.
 *Above nozzle, the thermocouple is J type.
 *Above parameter is subject to change without notice.

特点，优点：

- 高流量设计，适合大面积，大体积注射。
- 换色迅速。
- 适合表面允许有料把的塑料产品。
- 适用于普通材料和工程塑料的成型。
- 适用于磨损性与含有填料的塑料成型。
- 德国电加热元件和热电偶。
- 德国进口钢料经过精湛的热处理和合理精确的加工工艺。
- 经过4道尺寸和温控的严格检验。
- suitable for big surface and big volume injection.
- excellent color change performance.
- suitable for the plastic parts which allow the gate tails on it.
- suitable for normal & engineering plastic raw material injection.
- suitable for durable, hard plastic material & Glass Fiber added plastic material injection.
- German origin heating elements and thermocouple.
- German steel by correct harden treatment and precision tooling processing.
- Each nozzle from the beginning until the well finished, there are 4 times dimension controlling and temperature controlling inspections.



*用该喷嘴注塑成型后的浇口效果图

MTHSB-M

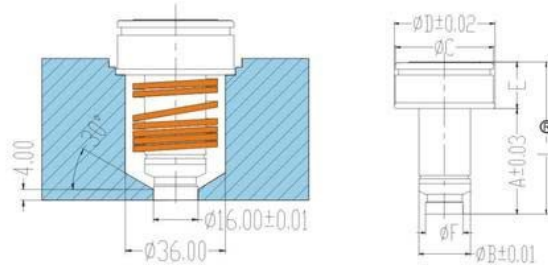
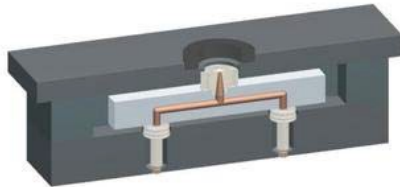

注：“R”为膨胀量 “R” referring heat expending rate

MTHSB-M	A	B	C	D	E	F	L	加热圈长度 Coil heater ϕ & length	功率 Power	铜套加热圈 Copper sleeve coil
MTHSB-M22-68	48	22	42	43	20	16	68	$\phi 22 \times 35$	380W	
MTHSB-M22-75	55	22	42	43	20	16	75	$\phi 22 \times 42$	420W	
MTHSB-M22-85	65	22	42	43	20	16	85	$\phi 22 \times 52$	500W	
MTHSB-M22-95	75	22	42	43	20	16	95	$\phi 22 \times 62$	530W	
MTHSB-M22-105	85	22	42	43	20	16	105	$\phi 22 \times 72$	650W	420W
MTHSB-M22-115	95	22	42	43	20	16	115	$\phi 22 \times 82$	690W	460W
MTHSB-M22-125	105	22	42	43	20	16	125	$\phi 22 \times 92$	760W	500W
MTHSB-M22-135	115	22	42	43	20	16	135	$\phi 22 \times 102$	840W	530W

- *以上喷嘴加热圈功率在900W以下的，其直条截面尺寸是：X * Y = 4.2 * 2.2mm (X为宽度，Y为厚度)
- *以上喷嘴加热圈功率在900W以上的，根据喷嘴的要求，其直条截面尺寸另定。
- *以上喷嘴热电偶为J型。
- *以上参数若有改动，恕难及时通知。

- *Above nozzle, the coiled heater diameter indication is meaning the inner diameter.
- *Above nozzle, the coiled heater power below 900W, the section dimension is 4.2x2.2mm (width x thickness). If the power over 900W, heater's section dimension will be same or subject to change.
- *Above nozzle, the thermocouple is J type.
- *Above parameter is subject to change without notice.

特点，优点：

- 高流量设计，适合大面积，大体积注射。
- 换色迅速。
- 适合表面允许有料把的塑料产品。
- 适用于普通材料和工程塑料的成型。
- 适用于磨损性与含有填料的塑料成型。
- 德国电加热元件和热电偶。
- 德国进口钢料经过精湛的热处理和合理精确的加工工艺。
- 经过4道尺寸和温控的严格检验。
- suitable for big surface and big volume injection.
- excellent color change performance.
- suitable for the plastic parts which allow the gate tails on it.
- suitable for normal & engineering plastic raw material injection.
- suitable for durable, hard plastic material & Glass Fiber added plastic material injection.
- German origin heating elements and thermocouple.
- German steel by correct harden treatment and precision tooling processing.
- Each nozzle from the beginning until the well finished, there are 4 times dimension controlling and temperature controlling inspections.

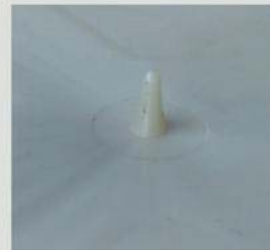

*用该喷嘴注塑成型后的浇口效果图

MTHSB-M

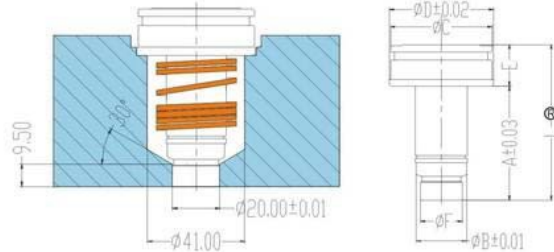
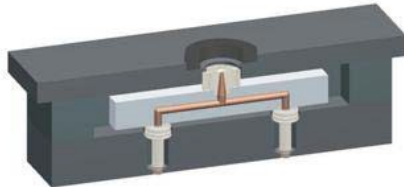

注：“R”为膨胀量 “R” referring heat expending rate

MTHSB-M	A	B	C	D	E	F	L	加热圈长度 Coil heater & length	功率 Power	铜套加热圈 Copper sleeve coil
MTHSB-M25-75	55	25	49	50	20	20	75	φ22x35	420W	
MTHSB-M25-85	65	25	49	50	20	20	85	φ22x45	500W	
MTHSB-M25-95	75	25	49	50	20	20	95	φ22x55	530W	420W
MTHSB-M25-105	85	25	49	50	20	20	105	φ22x65	650W	460W
MTHSB-M25-115	95	25	49	50	20	20	115	φ22x75	760W	530W
MTHSB-M25-125	105	25	49	50	20	20	125	φ22x85	840W	610W
MTHSB-M25-135	115	25	49	50	20	20	135	φ22x95	840W	690W
MTHSB-M25-145	125	25	49	50	20	20	145	φ22x105	840W	760W

*以上喷嘴加热圈功率在900W以下的，其直条截面尺寸是：X*Y=4.2*2.2mm（X为宽度，Y为厚度）

*以上喷嘴加热圈功率在900W以上的，根据喷嘴的要求，其直条截面尺寸另定。

*以上喷嘴热电偶为J型。

*以上参数若有改动，恕难及时通知。

*Above nozzle, the coiled heater diameter indication is meaning the inner diameter.

*Above nozzle, the coiled heater power below 900W, the section dimension is 4.2x2.2mm (width x thickness). If the power over 900W, heater's section dimension will be same or subject to change.

*Above nozzle, the thermocouple is J type.

*Above parameter is subject to change without notice.

特点，优点：

- 高流量设计，适合大面积，大体积注射。
- 换色迅速。
- 适合表面允许有料把的塑料产品。
- 适用于普通材料和工程塑料的成型。
- 适用于磨损性与含有填料的塑料成型。
- 德国电加热元件和热电偶。
- 德国进口钢料经过精湛的热处理和合理精确的加工工艺。
- 经过4道尺寸和温控的严格检验。

- suitable for big surface and big volume injection.
- excellent color change performance.
- suitable for the plastic parts which allow the gate tails on it.
- suitable for normal & engineering plastic raw material injection.
- suitable for durable, hard plastic material & Glass Fiber added plastic material injection.
- German origin heating elements and thermocouple.
- German steel by correct harden treatment and precision tooling processing
- Each nozzle from the beginning until the well finished, there are 4 times dimension controlling and temperature controlling inspections.



*用该喷嘴注塑成型后的浇口效果图

MTHSB-L

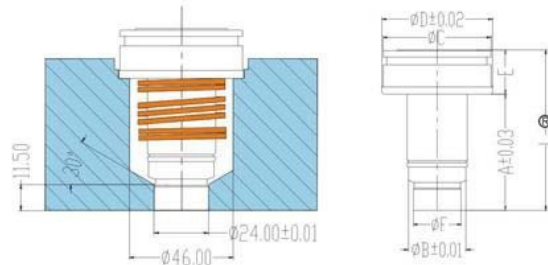
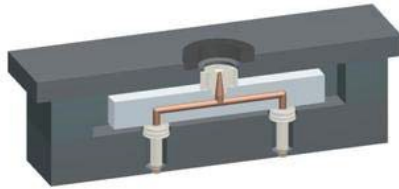

注：“R”为膨胀量 “R” referring heat expending rate

MTHSB-L	A	B	C	D	E	F	L	加热圈长度 Coil heater ϕ & length	功率 Power
MTHSB-L30-80	58	30	54	55	22	24	80	待定 to be determined	待定 to be determined
MTHSB-L30-90	68	30	54	55	22	24	90		
MTHSB-L30-100	78	30	54	55	22	24	100		
MTHSB-L30-110	88	30	54	55	22	24	110		
MTHSB-L30-120	98	30	54	55	22	24	120		
MTHSB-L30-130	108	30	54	55	22	24	130		
MTHSB-L30-140	118	30	54	55	22	24	140		
MTHSB-L30-150	128	30	54	55	22	24	150		
MTHSB-L30-160	138	30	54	55	22	24	160		
MTHSB-L30-170	148	30	54	55	22	24	170		

*以上喷嘴加热圈功率在900W以下的，其直条截面尺寸是：X * Y = 4.2 * 2.2mm (X为宽度，Y为厚度)

*以上喷嘴加热圈功率在900W以上的，根据喷嘴的要求，其直条截面尺寸另定。

*以上喷嘴热电偶为J型。

*以上参数若有改动，恕难及时通知。

*Above nozzle, the coiled heater diameter indication is meaning the inner diameter.

*Above nozzle, the coiled heater power below 900W, the section dimension is 4.2x2.2mm (width x thickness). If the power over 900W, heater's section dimension will be same or subject to change.

*Above nozzle, the thermocouple is J type.

*Above parameter is subject to change without notice.

特点，优点：

- 高流量设计，适合大面积，大体积注射。
- 换色迅速。
- 适合表面允许有料把的塑料产品。
- 适用于普通材料和工程塑料的成型。
- 适用于磨损性与含有填料的塑料成型。
- 德国电加热元件和热电偶。
- 德国进口钢料经过精湛的热处理和合理精确的加工工艺。
- 经过4道尺寸和温控的严格检验。

- suitable for big surface and big volume injection.
- excellent color change performance.
- suitable for the plastic parts which allow the gate tails on it.
- suitable for normal & engineering plastic raw material injection.
- suitable for durable, hard plastic material & Glass Fiber added plastic material injection.
- German origin heating elements and thermocouple.
- German steel by correct harden treatment and precision tooling processing.
- Each nozzle from the beginning until the well finished, there are 4 times dimension controlling and temperature controlling inspections.



*用该喷嘴注塑成型后的浇口效果图

MTHSB-L

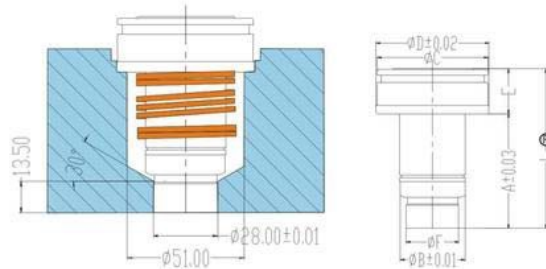
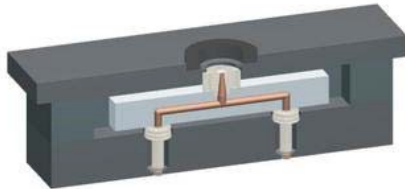

注：“R”为膨胀量 “R” referring heat expending rate

MTHSB-L	A	B	C	D	E	F	L	加热圈长度 Coil heater ϕ & length	功率 Power
MTHSB-L35-85	61	35	59	60	24	28	85	待定 to be determined	待定 to be determined
MTHSB-L35-95	71	35	59	60	24	28	95		
MTHSB-L35-105	81	35	59	60	24	28	105		
MTHSB-L35-115	91	35	59	60	24	28	115		
MTHSB-L35-125	101	35	59	60	24	28	125		
MTHSB-L35-135	111	35	59	60	24	28	135		
MTHSB-L35-145	121	35	59	60	24	28	145		
MTHSB-L35-155	131	35	59	60	24	28	155		
MTHSB-L35-165	141	35	59	60	24	28	165		
MTHSB-L35-175	151	35	59	60	24	28	175		

*以上喷嘴加热圈功率在900W以下的，其直条截面尺寸是：X * Y = 4.2 * 2.2mm (X为宽度，Y为厚度)
 *以上喷嘴加热圈功率在900W以上的，根据喷嘴的要求，其直条截面尺寸另定。
 *以上喷嘴热电偶为J型。
 *以上参数若有改动，恕难及时通知。

*Above nozzle, the coiled heater diameter indication is meaning the inner diameter.
 *Above nozzle, the coiled heater power below 900W, the section dimension is 4.2x2.2mm (width x thickness). If the power over 900W, heater's section dimension will be same or subject to change.
 *Above nozzle, the thermocouple is J type.
 *Above parameter is subject to change without notice.

特点，优点：

- 高流量设计，适合大面积，大体积注射。
- 换色迅速。
- 适合表面允许有料把的塑料产品。
- 适用于普通材料和工程塑料的成型。
- 适用于磨损性与含有填料的塑料成型。
- 德国电加热元件和热电偶。
- 德国进口钢料经过精湛的热处理和合理精确的加工工艺。
- 经过4道尺寸和温控的严格检验。
- suitable for big surface and big volume injection.
- excellent color change performance.
- suitable for the plastic parts which allow the gate tails on it.
- suitable for normal & engineering plastic raw material injection.
- suitable for durable, hard plastic material & Glass Fiber added plastic material injection.
- German origin heating elements and thermocouple.
- German steel by correct harden treatment and precision tooling processing.
- Each nozzle from the beginning until the well finished, there are 4 times dimension controlling and temperature controlling inspections.



*用该喷嘴注塑成型后的浇口效果图

MTHSB- I -M

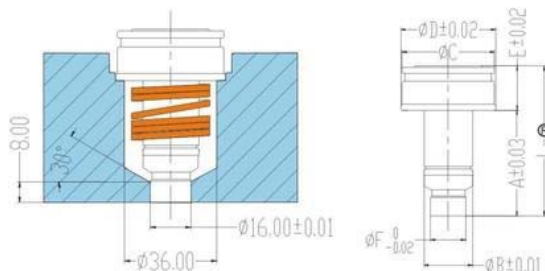
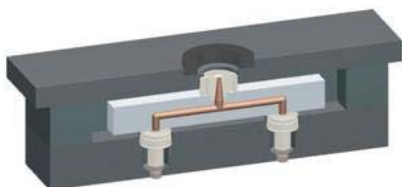

注：“R”为膨胀量 “R” referring heat expending rate

MTHSB- I -M	A	B	C	D	E	F	L	加热圈长度 Coil heater ϕ & length	功率 Power	铜套加热圈 Copper sleeve coil
MTHSB- I -M22-68	48	22	42	43	20	16	68	ϕ 22x32	380W	
MTHSB- I -M22-75	55	22	42	43	20	16	75	ϕ 22x42	420W	
MTHSB- I -M22-85	65	22	42	43	20	16	85	ϕ 22x52	500W	
MTHSB- I -M22-95	75	22	42	43	20	16	95	ϕ 22x62	530W	
MTHSB- I -M22-105	85	22	42	43	20	16	105	ϕ 22x72	650W	420W
MTHSB- I -M22-115	95	22	42	43	20	16	115	ϕ 22x82	690W	460W
MTHSB- I -M22-125	105	22	42	43	20	16	125	ϕ 22x92	760W	500W
MTHSB- I -M22-135	115	22	42	43	20	16	135	ϕ 22x102	840W	530W

*以上喷嘴加热圈功率在900W以下的，其直条截面尺寸是：X * Y = 4.2 * 2.2mm (X为宽度，Y为厚度)

*以上喷嘴加热圈功率在900W以上的，根据喷嘴的要求，其直条截面尺寸另定。

*以上喷嘴热电偶为J型。

*以上参数若有改动，恕难及时通知。

*Above nozzle, the coiled heater diameter indication is meaning the inner diameter.

*Above nozzle, the coiled heater power below 900W, the section dimension is 4.2x2.2mm (width x thickness). If the power over 900W, heater's section dimension will be same or subject to change.

*Above nozzle, the thermocouple is J type.

*Above parameter is subject to change without notice.

特点，优点：

- 杰出的设计，保证换色迅速，最大可能地减少热量散失。
- 表面有针点痕迹的进料口。
- 适用于高流动性塑料的成型。
- 德国电加热元件和热电偶。
- 德国进口钢料经过精湛的热处理和合理精确的加工工艺。
- 经过4道尺寸和温控的严格检验。

-outstanding design guaranteed fast color changes & prevented heating transfer to the mould

-on the plastic parts surface, there is pin point mark.

-suitable for high melting flow index material injection.

-German origin heating elements and thermocouple.

-German steel by correct harden treatment and precision tooling processing.

-Each nozzle from the beginning until the well finished, there are 4 times dimension controlling and temperature controlling inspections



*用该喷嘴注塑成型后的浇口效果图

MTHSB- I -L

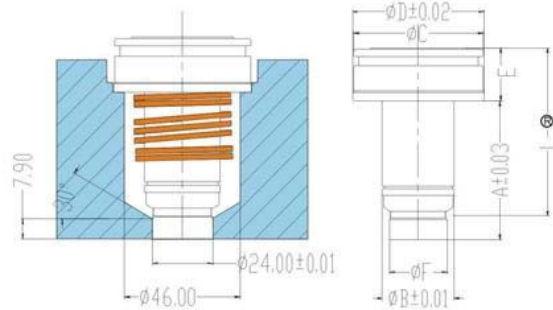
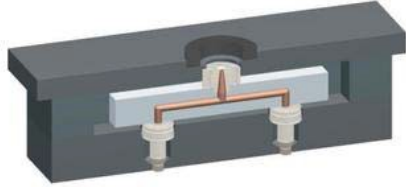

注：“R”为膨胀量 “R” referring heat expending rate

MTHSB- I -L	A	B	C	D	E	F	L	加热圈长度 Coil heater ϕ & length	功率 Power
MTHSB- I -L30-80	58	30	54	55	22	24	80	待定 to be determined	待定 to be determined
MTHSB- I -L30-90	68	30	54	55	22	24	90		
MTHSB- I -L30-100	78	30	54	55	22	24	100		
MTHSB- I -L30-110	88	30	54	55	22	24	110		
MTHSB- I -L30-120	98	30	54	55	22	24	120		
MTHSB- I -L30-130	108	30	54	55	22	24	130		
MTHSB- I -L30-140	118	30	54	55	22	24	140		
MTHSB- I -L30-150	128	30	54	55	22	24	150		
MTHSB- I -L30-160	138	30	54	55	22	24	160		
MTHSB- I -L30-170	148	30	54	55	22	24	170		

*以上喷嘴加热圈功率在900W以下的，其直条截面尺寸是：X * Y = 4.2 * 2.2mm (X为宽度，Y为厚度)

*以上喷嘴加热圈功率在900W以上的，根据喷嘴的要求，其直条截面尺寸另定。

*以上喷嘴热电偶为J型。

*以上参数若有改动，恕难及时通知。

*Above nozzle, the coiled heater diameter indication is meaning the inner diameter.

*Above nozzle, the coiled heater power below 900W, the section dimension is 4.2x2.2mm (width x thickness). If the power over 900W, heater's section dimension will be same or subject to change.

*Above nozzle, the thermocouple is J type.

*Above parameter is subject to change without notice.

特点，优点：

- 杰出的设计，保证换色迅速，最大可能地减少热量散失。
- 表面有针点痕迹的进料口。
- 适用于高流动性塑料的成型。
- 德国电加热元件和热电偶。
- 德国进口钢料经过精湛的热处理和合理精确的加工工艺。
- 经过4道尺寸和温控的严格检验。

-outstanding design guaranteed fast color changes & prevented heating transfer to the mould

-on the plastic parts surface, there is pin point mark.

-suitable for high melting flow index material injection.

-German origin heating elements and thermocouple.

-German steel by correct harden treatment and precision tooling processing.

-Each nozzle from the beginning until the well finished, there are 4 times dimension controlling and temperature controlling inspections

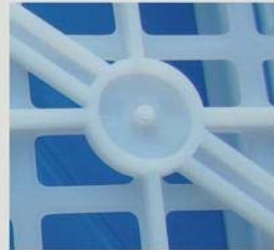

*用该喷嘴注塑成型后的浇口效果图

MTHSB- I -L

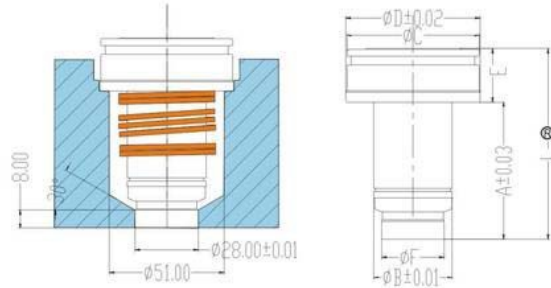
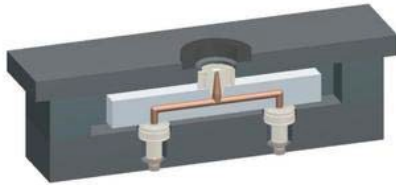

注：“R”为膨胀量 “R” referring heat expending rate

MTHSB- I -L	A	B	C	D	E	F	L	加热圈长度 Coil heater ϕ & length	功率 Power
MTHSB- I -L35-85	61	35	59	60	24	28	85	待定 to be determined	待定 to be determined
MTHSB- I -L35-95	71	35	59	60	24	28	95		
MTHSB- I -L35-105	81	35	59	60	24	28	105		
MTHSB- I -L35-115	91	35	59	60	24	28	115		
MTHSB- I -L35-125	101	35	59	60	24	28	125		
MTHSB- I -L35-135	111	35	59	60	24	28	135		
MTHSB- I -L35-145	121	35	59	60	24	28	145		
MTHSB- I -L35-155	131	35	59	60	24	28	155		
MTHSB- I -L35-165	141	35	59	60	24	28	165		
MTHSB- I -L35-175	151	35	59	60	24	28	175		

*以上喷嘴加热圈功率在900W以下的，其直条截面尺寸是：X * Y = 4.2 * 2.2mm (X为宽度，Y为厚度)

*以上喷嘴加热圈功率在900W以上的，根据喷嘴的要求，其直条截面尺寸另定。

*以上喷嘴热电偶为J型。

*以上参数若有改动，恕难及时通知。

*Above nozzle, the coiled heater diameter indication is meaning the inner diameter.

*Above nozzle, the coiled heater power below 900W, the section dimension is 4.2x2.2mm (width x thickness). If the power over 900W, heater's section dimension will be same or subject to change.

*Above nozzle, the thermocouple is J type.

*Above parameter is subject to change without notice.

特点，优点：

- 杰出的设计，保证换色迅速，最大可能地减少热量散失。
- 表面有针点痕迹的进料口。
- 适用于高流动性塑料的成型。
- 德国电加热元件和热电偶。
- 德国进口钢料经过精湛的热处理和合理精确的加工工艺。
- 经过4道尺寸和温控的严格检验。

-outstanding design guaranteed fast color changes & prevented heating transfer to the mould.

-on the plastic parts surface, there is pin point mark.

-suitable for high melting flow index material injection.

-German origin heating elements and thermocouple.

-German steel by correct harden treatment and precision tooling processing.

-Each nozzle from the beginning until the well finished, there are 4 times dimension controlling and temperature controlling inspections.

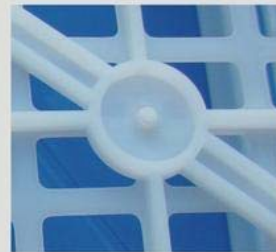

*用该喷嘴注塑成型后的浇口效果图

VGST-S

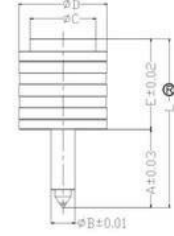
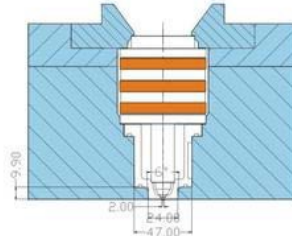
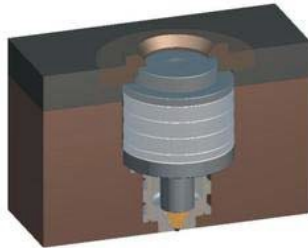

注：“R”为膨胀量 “R” referring heat expending rate

VGST-S	A	B	C	D	E	L	加热圈长度 Coil heater ϕ & length	功率 Power	铜套加热圈 Copper sleeve coil
VGST-S19-130	58	19	52	70	72	130	ϕ 19x50	460W	
VGST-S19-140	68	19	52	70	72	140	ϕ 19x60	530W	
VGST-S19-150	78	19	52	70	72	150	ϕ 19x70	610W	420W
VGST-S19-160	88	19	52	70	72	160	ϕ 19x80	690W	460W
VGST-S19-170	98	19	52	70	72	170	ϕ 19x90	760W	500W
VGST-S19-180	108	19	52	70	72	180	ϕ 19x100	840W	530W
VGST-S19-190	118	19	52	70	72	190	ϕ 19x110	840W	610W
VGST-S19-200	128	19	52	70	72	200	ϕ 19x110	840W	690W

- *以上喷嘴加热圈功率在900W以下的，其直条截面尺寸是：X * Y = 4.2 * 2.2mm (X为宽度，Y为厚度)
- *以上喷嘴加热圈功率在900W以上的，根据喷嘴的要求，其直条截面尺寸另定。
- *以上喷嘴热电偶为J型。
- *以上参数若有改动，恕难及时通知。

- *Above nozzle, the coiled heater diameter indication is meaning the inner diameter.
- *Above nozzle, the coiled heater power below 900W, the section dimension is 4.2x2.2mm (width x thickness). If the power over 900W, heater's section dimension will be same or subject to change.
- *Above nozzle, the thermocouple is J type.
- *Above parameter is subject to change without notice.

特点，优点：

- 杰出的设计，保证换色迅速，最大可能地减少热量散失。
- 适合大面积，大体积注射快速注射。
- 适合硬质工程塑料注射。
- 适合高流动性塑料，如PA，PET……注射，以防溢料。
- 表面有轻微的圆形痕迹的进料口。
- 德国电加热元件和热电偶。
- 德国进口钢料经过精湛的热处理和合理精确的加工工艺。
- 英国进口耐高温密封圈和耐高温耐磨圈。
- 阀针经过300万次循环测试，不出现明显磨损。
- 经过4道尺寸和温控的严格检验。
- outstanding design guaranteed fast color changes & prevented heating transfer to the mould.
- suitable for big surface, big volume plastic parts high speed injection
- suitable for hard plastic material & engineering plastic material injection.
- suitable for high melting flow index material injection, such like PA, PET..., to prevent the plastic material overflow into the cavities after the injection stopped.
- on the plastic part surface, there is a small slight circle gate mark.
- German origin heating elements and thermocouple.
- German steel by correct harden treatment and precision tooling processing.
- U.K. high temperature resist o-ring & high temperature resist durable ring.
- valve pin tested by 3 million cycles without any obvious damage.
- Each nozzle from the beginning until the well finished, there are 4 times dimension controlling and temperature controlling inspections.



*用该喷嘴注塑成型后的浇口效果图

VGST-M

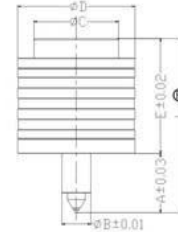
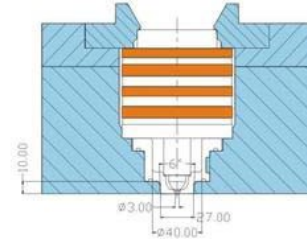
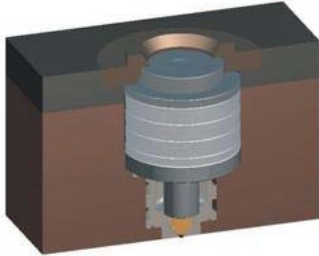

注：“R”为膨胀量 “R” referring heat expending rate

VGST-M	A	B	C	D	E	L	加热圈长度 Coil heater ϕ & length	功率 Power	铜套加热圈 Copper sleeve coil
VGST-M 22-135	44.6	22	65	90	88.4	135	ϕ 22x40	420W	
VGST-M 22-145	56.6	22	65	90	88.4	145	ϕ 22x50	460W	
VGST-M 22-155	66.6	22	65	90	88.4	155	ϕ 22x60	570W	
VGST-M 22-165	76.6	22	65	90	88.4	165	ϕ 22x70	650W	460W
VGST-M 22-175	86.6	22	65	90	88.4	175	ϕ 22x80	760W	500W
VGST-M 22-185	96.6	22	65	90	88.4	185	ϕ 22x90	840W	530W
VGST-M 22-195	106.6	22	65	90	88.4	195	ϕ 22x100	840W	570W
VGST-M 22-205	116.6	22	65	90	88.4	205	ϕ 22x110	840W	650W

- *以上喷嘴加热圈功率在900W以下的，其直条截面尺寸是：X * Y = 4.2 * 2.2mm (X为宽度，Y为厚度)
- *以上喷嘴加热圈功率在900W以上的，根据喷嘴的要求，其直条截面尺寸另定。
- *以上喷嘴热电偶为J型。
- *以上参数若有改动，恕难及时通知。

- *Above nozzle, the coiled heater diameter indication is meaning the inner diameter.
- *Above nozzle, the coiled heater power below 900W, the section dimension is 4.2x2.2mm (width x thickness). If the power over 900W, heater's section dimension will be same or subject to change.
- *Above nozzle, the thermocouple is J type.
- *Above parameter is subject to change without notice.

特点，优点：

- 杰出的设计，保证换色迅速，最大可能地减少热量散失。
- 适合大面积，大体积注射快速注射。
- 适合硬质工程塑料注射。
- 适合高流动性塑料，如PA, PET……注射，以防溢料。
- 表面有轻微的圆形痕迹的进料口。
- 德国电加热元件和热电偶。
- 德国进口钢料经过精湛的热处理和合理精确的加工工艺。
- 英国进口耐高温密封圈和耐高温耐磨圈。
- 阀针经过300万次循环测试，不出现明显磨损。
- 经过4道尺寸和温控的严格检验。
- outstanding design guaranteed fast color changes & prevented heating transfer to the mould.
- suitable for big surface, big volume plastic parts high speed injection.
- suitable for hard plastic material & engineering plastic material injection.
- suitable for high melting flow index material injection, such like PA, PET..., to prevent the plastic material overflow into the cavities after the injection stopped.
- on the plastic part surface, there is a small slight circle gate mark.
- German origin heating elements and thermocouple.
- German steel by correct harden treatment and precision tooling processing.
- U.K. high temperature resist o-ring & high temperature resist durable ring.
- valve pin tested by 3 million cycles without any obvious damage.
- Each nozzle from the beginning until the well finished, there are 4 times dimension controlling and temperature controlling inspections.



*用该喷嘴注塑成型后的浇口效果图

VGST-L

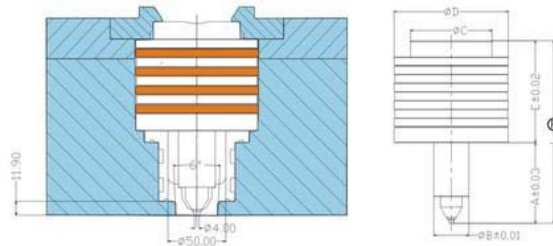
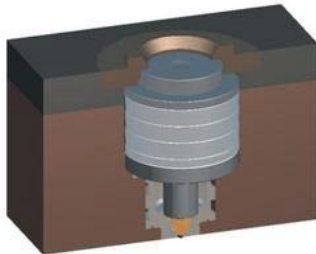

注：“R”为膨胀量 “R” referring heat expending rate

VGST-L	A	B	C	D	E	L	加热圈长度 Coil heater & length	功率 Power	铜套加热圈 Copper sleeve coil
VGST-L 32-155	61.4	32	75	105	93.6	155	$\phi 22 \times 40$	420W	
VGST-L 32-165	71.4	32	75	105	93.6	165	$\phi 22 \times 50$	460W	
VGST-L 32-175	81.4	32	75	105	93.6	175	$\phi 22 \times 60$	570W	
VGST-L 32-185	91.4	32	75	105	93.6	185	$\phi 22 \times 70$	650W	460W
VGST-L 32-195	101.4	32	75	105	93.6	195	$\phi 22 \times 80$	760W	500W
VGST-L 32-205	111.4	32	75	105	93.6	205	$\phi 22 \times 90$	840W	530W
VGST-L 32-215	121.4	32	75	105	93.6	215	$\phi 22 \times 100$	840W	570W
VGST-L 32-225	131.4	32	75	105	93.6	225	$\phi 22 \times 110$	840W	650W

- *以上喷嘴加热圈功率在900W以下的，其直条截面尺寸是：X*Y=4.2*2.2mm（X为宽度，Y为厚度）
- *以上喷嘴加热圈功率在900W以上的，根据喷嘴的要求，其直条截面尺寸另定。
- *以上喷嘴热电偶为J型。
- *以上参数若有改动，恕难及时通知。

- *Above nozzle, the coiled heater diameter indication is meaning the inner diameter.
- *Above nozzle, the coiled heater power below 900W, the section dimension is 4.2x2.2mm (width x thickness). If the power over 900W, heater's section dimension will be same or subject to change.
- *Above nozzle, the thermocouple is J type.
- *Above parameter is subject to change without notice.

特点，优点：

- 杰出的设计，保证换色迅速，最大可能地减少热量散失。
- 适合大面积，大体积注射快速注射。
- 适合硬质工程塑料注射。
- 适合高流动性塑料，如PA，PET……注射，以防溢料。
- 表面有轻微的圆形痕迹的进料口。
- 德国电加热元件和热电偶。
- 德国进口钢料经过精湛的热处理和合理精确的加工工艺。
- 英国进口耐高温密封圈和耐高温耐磨圈。
- 阀针经过300万次循环测试，不出现明显磨损。
- 经过4道尺寸和温控的严格检验。

- outstanding design guaranteed fast color changes & prevented heating transfer to the mould.
- suitable for big surface, big volume plastic parts high speed injection.
- suitable for hard plastic material & engineering plastic material injection.
- suitable for high melting flow index material injection, such like PA, PET... to prevent the plastic material overflow into the cavities after the injection stopped.
- on the plastic part surface, there is a small slight circle gate mark.
- German origin heating elements and thermocouple.
- German steel by correct harden treatment and precision tooling processing.
- U.K. high temperature resist o-ring & high temperature resist durable ring.
- valve pin tested by 3 million cycles without any obvious damage.
- Each nozzle from the beginning until the well finished, there are 4 times dimension controlling and temperature controlling inspections.



*用该喷嘴注塑成型后的浇口效果图

VGST-L

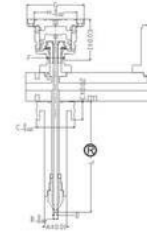
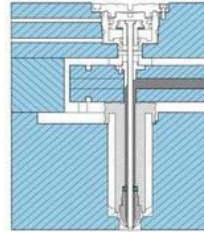
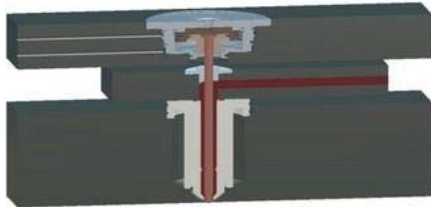

注：“R”为膨胀量 “R” referring heat expending rate

VGMT-L	A	B	C	D	E	F	G	H	I	L	加热圈长度 Coil heater ϕ & length	功率 Power	铜套加热圈 Copper sleeve coil
VGMT-L 35-80	35	7.8	60	3	30	27.9	90	67.9	64.8	80	ϕ 35x45	610W	460W
VGMT-L 35-90	35	7.8	60	3	30	27.9	90	67.9	64.8	90	ϕ 35x55	690W	500W
VGMT-L 35-100	35	7.8	60	3	30	27.9	90	67.9	64.8	100	ϕ 35x65	840W	530W
VGMT-L 35-110	35	7.8	60	3	30	27.9	90	67.9	64.8	110	ϕ 35x75	840W	610W
VGMT-L 35-120	35	7.8	60	3	30	27.9	90	67.9	64.8	120	ϕ 35x85	850W	690W
VGMT-L 35-130	35	7.8	60	3	30	27.9	90	67.9	64.8	130	ϕ 35x95	850W	840W
VGMT-L 35-140	35	7.8	60	3	30	27.9	90	67.9	64.8	140	ϕ 35x105	1050W	840W
VGMT-L 35-150	35	7.8	60	3	30	27.9	90	67.9	64.8	150	ϕ 35x115	1250W	840W

*以上喷嘴加热圈功率在900W以下的，其直条截面尺寸是：X * Y = 4.2 * 2.2mm (X为宽度，Y为厚度)
*以上喷嘴加热圈功率在900W以上的，根据喷嘴的要求，其直条截面尺寸另定。
*以上喷嘴热电偶为J型。
*以上参数若有改动，恕难及时通知。

*Above nozzle, the coiled heater diameter indication is meaning the inner diameter.
*Above nozzle, the coiled heater power below 900W, the section dimension is 4.2x2.2mm (width x thickness). If the power over 900W, heater's section dimension will be same or subject to change.
*Above nozzle, the thermocouple is J type.
*Above parameter is subject to change without notice.

特点，优点：

- 杰出的设计，保证换色迅速，最大可能地减少热量散失。
- 适合大面积，大体积注射快速注射。
- 适合硬质工程塑料注射。
- 适合高流动性塑料，如PA，PET……注射，以防溢料。
- 表面有轻微的圆形痕迹的进料口。
- 德国电加热元件和热电偶。
- 德国进口钢料经过精湛的热处理和合理精确的加工工艺。
- 英国进口耐高温密封圈和耐高温耐磨圈。
- 阀针经过300万次循环测试，不出现明显磨损。
- 经过4道尺寸和温控的严格检验。
- outstanding design guaranteed fast color changes & prevented heating transfer to the mould.
- suitable for big surface, big volume plastic parts high speed injection.
- suitable for hard plastic material & engineering plastic material injection.
- suitable for high melting flow index material injection; such like PA, PET..., to prevent the plastic material overflow into the cavities after the injection stopped.
- on the plastic part surface, there is a small slight circle gate mark.
- German origin heating elements and thermocouple.
- German steel by correct harden treatment and precision tooling processing.
- U.K. high temperature resist o-ring & high temperature resist durable ring.
- valve pin tested by 3 million cycles without any obvious damage.
- Each nozzle from the beginning until the well finished, there are 4 times dimension controlling and temperature controlling inspections.



*用该喷嘴注塑成型后的浇口效果图

VGMT- I -M

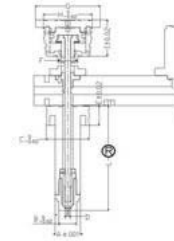
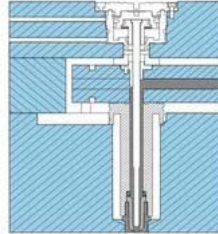
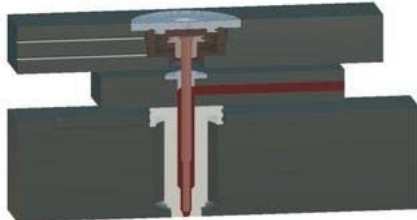

注：“R”为膨胀量 “R” referring heat expending rate

VGMT- I -M	A	B	C	D	E	F	G	H	I	L	加热圈长度 Coil heater & length	功率 Power	铜套加热圈 Copper sleeve coil
VGMT- I -M 35-80	35	25	60	3	30	27	990	67	964	8125	Φ35x45	610W	460W
VGMT- I -M 35-90	35	25	60	3	30	27	990	67	964	8125	Φ35x55	690W	500W
VGMT- I -M 35-100	35	25	60	3	30	27	990	67	964	8125	Φ35x65	840W	530W
VGMT- I -M 35-110	35	25	60	3	30	27	990	67	964	8125	Φ35x75	840W	610W
VGMT- I -M 35-120	35	25	60	3	30	27	990	67	964	8125	Φ35x85	850W	690W
VGMT- I -M 35-130	35	25	60	3	30	27	990	67	964	8125	Φ35x95	850W	840W
VGMT- I -M 35-140	35	25	60	3	30	27	990	67	964 <td 8125	Φ35x105	1050W	840W	
VGMT- I -M 35-150	35	25	60	3	30	27	990	67	964	8125	Φ35x115	1250W	840W

*以上喷嘴加热圈功率在900W以下的，其直条截面尺寸是：X * Y = 4.2 * 2.2mm (X为宽度， Y为厚度)

*以上喷嘴加热圈功率在900W以上的，根据喷嘴的要求，其直条截面尺寸另定。

*以上喷嘴热电偶为J型。

*以上参数若有改动，恕难及时通知。

*Above nozzle, the coiled heater diameter indication is meaning the inner diameter.

*Above nozzle, the coiled heater power below 900W, the section dimension is 4.2x2.2mm (width x thickness). If the power over 900W, heater's section dimension will be same or subject to change.

*Above nozzle, the thermocouple is J type.

*Above parameter is subject to change without notice.

特点，优点：

- 杰出的设计，保证换色迅速，最大可能地减少热量散失。
 - 适合大面积，大体积注射快速注射。
 - 适合硬质工程塑料注射。
 - 适合高流动性塑料，如PA, PET……注射，以防溢料。
 - 表面有轻微的圆形痕迹的进料口。
 - 德国电加热元件和热电偶。
 - 德国进口钢料经过精湛的热处理和合理精确的加工工艺。
 - 英国进口耐高温密封圈和耐高温耐磨圈。
 - 阀针经过300万次循环测试，不出现明显磨损。
 - 经过4道尺寸和温控的严格检验。
- outstanding design guaranteed fast color changes & prevented heating transfer to the mould.
 - suitable for big surface, big volume plastic parts high speed injection.
 - suitable for hard plastic material & engineering plastic material injection.
 - suitable for high melting flow index material injection, such like PA, PET..., to prevent the plastic material overflow into the cavities after the injection stopped.
 - on the plastic part surface, there is a small slight circle gate mark.
 - German origin heating elements and thermocouple.
 - German steel by correct harden treatment and precision tooling processing.
 - U.K. high temperature resist o-ring & high temperature resist durable ring.
 - valve pin tested by 3 million cycles without any obvious damage.
 - Each nozzle from the beginning until the well finished, there are 4 times dimension controlling and temperature controlling inspections.



*用该喷嘴注塑成型后的浇口效果图

CHINA