

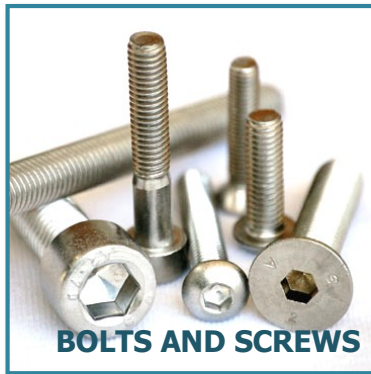

FASTENERS



BOLTS, SCREWS AND SOCKETS

HEXAGON HEAD SCREWS

DIN 933

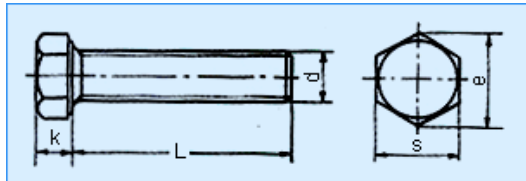

STRENGTH GRADE
8.8
10.9
12.9

mm

Thread size	M4	M5	M6	M8	M10	M12	M14	M16	M18	M20	M22	M24	M27	M30
Pitch	0.7	0.8	1	1.25	1.5	1.75	2	2	2.5	2.5	2.5	3	3	3.5
k	2.8	3.5	4	5.3	6.4	7.5	8.8	10	11.5	12.5	14	15	17	18.7
e	Grade A	7.66	8.79	11.05	14.38	18.9	21.1	24.49	26.75	30.14	33.53	35.72	35.98	45.2
	Grade B	-	8.63	10.89	14.2	18.72	20.88	23.91	26.17	29.56	32.95	35.03	39.55	50.85
S	7	8	10	13	17	19	22	24	27	30	32	36	41	46
L	8-40	8-40	8-50	12-60	16-60	20-80	25-80	30-100	30-100	40-100	50-100	50-100	60-100	70-100

HEXAGON HEAD SCREWS

DIN 558

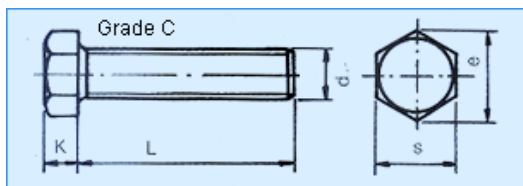

STRENGTH GRADE
8.8

mm

Thread size	M5	M6	M8	M10	M12	M16	M20	M24	M30	M36
Pitch	0.8	1	1.25	1.5	1.75	2	2.5	3	3.5	4
k	3.5	4	5.3	6.4	7.5	10	12.5	15	18.7	22.5
e	8.63	10.89	14.2	18.72	20.88	26.17	32.95	39.55	50.85	60.79
S	8	10	13	17	19	24	30	36	46	55
L	10-40	12-50	16-65	16-80	20-100	25-100	30-100	35-100	40-100	50-100

HEXAGON HEAD SCREWS

ISO 4017

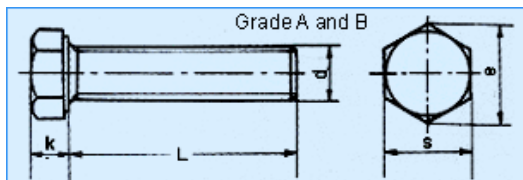

STRENGTH GRADE
8.8
10.9
12.9

mm

Thread size	M5	M6	M8	M10	M12	M16	M20	M24	M30	M36
Pitch	0.8	1	1.25	1.5	1.75	2	2.5	3	3.5	4
k	3.5	4	5.3	6.4	7.5	10	12.5	15	18.7	22.5
e	Grade A	8.79	11.05	14.38	17.77	20.03	26.75	33.53	39.98	-
	Grade B	-	-	-	-	-	26.17	32.95	39.55	50.85
S	8	10	13	16	18	24	30	36	46	55
L	8-40	8-50	12-60	16-60	20-80	30-100	40-100	50-100	70-100	80-100

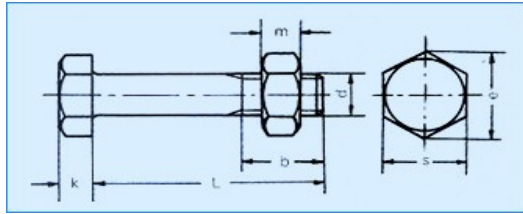
HEXAGON BOLTS WITH HEXAGON NUT
DIN 7990

STRENGTH GRADE

10.9

mm

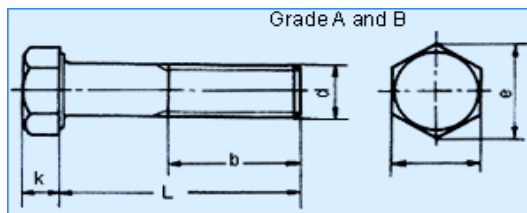
d1	M12	M16	M20	M22	M24	M27	M30
d	17.75	21	23.5	25.5	26	29	30.5
e	20.88	26.17	32.95	35.03	39.55	45.20	50.85
k	8	10	13	14	15	17	19
m	10	13	16	18	19	22	24
s	19	24	30	32	36	41	46
L	30-120	35-150	40-175	40-200	45-200	60-200	80-200

HEXAGON HEAD BOLTS
DIN 931

STRENGTH GRADE

 8.8
 10.9
 12.9

mm

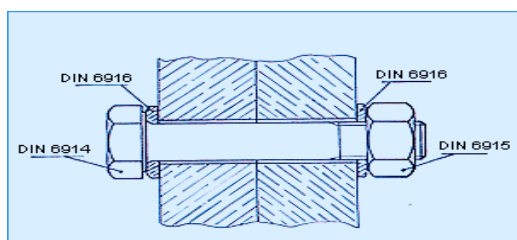
Thread size	M4	M5	M6	M8	M10	M12	M14	M16	M18	M20	M22	M24	M27	M30
Pitch	0.7	0.8	1	1.25	1.5	1.75	2	2	2.5	2.5	2.5	3	3	3.5
b	125	14	16	18	22	26	30	34	38	42	46	50	54	60
	L ≥ 200	-	22	24	28	32	36	40	44	48	52	56	60	66
	200	-	-	-	-	45	49	53	57	61	65	69	73	79
k	2.8	3.5	4	5.3	6.4	7.5	8.8	10	11.5	12.5	14	15	17	18.7
e	A	7.66	8.79	11.05	14.38	18.9	21.1	24.49	26.75	30.14	33.53	35.72	39.98	45.2
	B	-	8.63	10.89	14.20	18.72	20.88	23.91	26.17	29.56	32.95	35.03	39.55	45.2
S	7	8	10	13	17	19	22	24	27	30	32	36	41	46
L	25-40	25-50	30-60	35-80	40-100	45-120	50-140	55-160	65-180	65-200	70-220	80-240	90-260	90-300

HEXAGON BOLTS WITH LARGE WIDTHS ACROSS FLATS
DIN 6914

STRENGTH GRADE

10.9

mm

DIN6914	Diameter d	M12-M30	Length L	30-200
Nuts	Diameter D	M12-M30	-	-
Washers	Diameter d	M13-M31	-	-

HEXAGON HEAD BOLTS

DIN 601

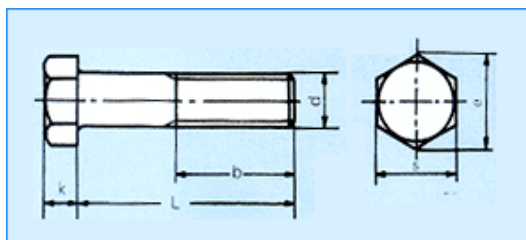

STRENGTH GRADE

4.8

mm

Thread size	M5	M6	M8	M10	M12	M16	M20	M24	M27	M30	M36	
Pitch	0.8	1	1.25	1.5	1.75	2	2.5	3	3	3.5	4	
b	L ≤ 125	16	18	22	26	30	38	46	54	60	66	78
	125 < L ≤ 200	22	24	28	32	36	44	52	60	66	72	84
	L > 200	35	37	41	45	49	57	65	73	79	85	97
k	3.5	4	5.3	6.4	7.5	10	12.5	15	17	18.7	22.5	
e	8.63	10.89	14.2	18.72	20.88	26.17	32.95	39.55	45.2	50.85	60.79	
S	8	10	13	17	19	24	30	36	41	46	55	
L	25-50	30-60	35-80	40-100	45-100	55-100	65-200	80-240	90-300	90-300	300	

HEXAGON HEAD BOLTS

ISO 4014

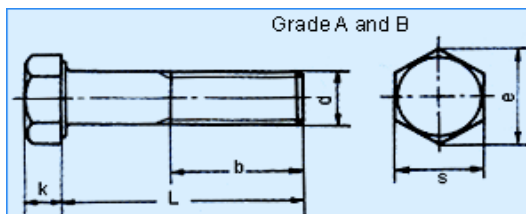

STRENGTH GRADE

8.8
10.9
12.9

mm

Thread size	M5	M6	M8	M10	M12	M16	M20	M24	M30	M36+	
Pitch	0.8	1	1.25	1.5	1.75	2	2.5	3	3.5	4	
b	L ≤ 125	16	18	22	26	30	38	46	54	66	-
	125 < L ≤ 200	-	-	-	-	-	44	52	60	72	84
	L > 200	-	-	-	-	-	-	73	85	97	-
k	3.5	4	5.3	6.4	7.5	10	12.5	15	18.7	22.5	
e	Grade A	8.79	11.05	14.38	17.77	20.03	26.75	33.53	39.98	-	-
	Grade B	-	-	-	-	-	26.17	32.95	39.56	50.85	60.79
S	8	10	13	16	18	24	30	36	46	55	
L	25-50	30-60	35-80	40-100	45-120	55-160	65-200	80-240	90-300	300	

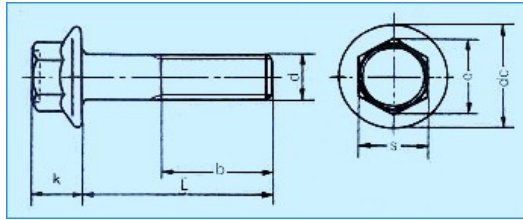
HEX FLANGE BOLTS & SCREWS
DIN 6921

STRENGTH GRADE
4.8
8.8

mm

Thread size	M5	M6	M8	M10	M12	M14	M16	M20
Pitch	0.8	1	1.25	1.5	1.75	2	2	2.5
b	L ≤ 125	16	18	22	26	30	34	46
	125 < L ≤ 200	-	-	28	32	36	40	52
	L > 200	-	-	-	-	-	-	65
dc	11.8	14.2	18	22.3	26.6	30.5	35	43
k	5.4	6.6	8.1	9.2	11.5	12.8	14.4	17.1
e	8.71	10.95	14.26	16.5	17.62	19.86	23.15	29.87
S	8	10	13	15	16	18	21	27
L	oct-50	dic-60	16-80	20-100	25-120	30-140	35-160	40-200

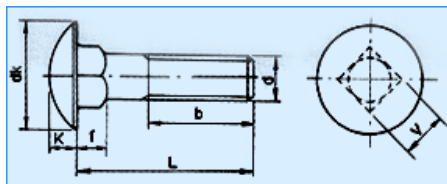
MUSHROOM HEAD SQUARE NECK BOLTS
DIN 603

STRENGTH GRADE
4.8
8.8

mm

Thread size	M6	M8	M10	M12
Pitch	1	1.25	1.5	1.75
b	L ≤ 125	18	22	30
	125 < L ≤ 200	24	28	36
	L > 200	-	41	49
dk	16.55	20.65	24.65	30.65
f	4.6	5.6	6.6	8.75
k	3.88	4.88	5.38	6.95
v	6.48	8.58	1.58	12.7
L	16-80	20-100	20-100	30-100

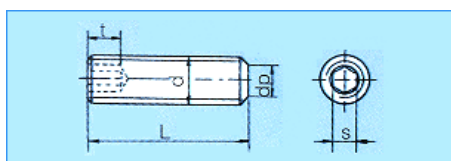
HEXAGON SOCKET SET SCREWS WITH FLAT POINT
DIN 913

mm

Thread size	M3	M4	M5	M6	M8	M10	M12	M16	M20
dp	2	2.5	3.5	4	5.5	7	8.5	12	15
s	1.5	2	2.5	3	4	5	6	8	10
t	1.2	1.5	2	2	3	4	4.8	6.4	8
L	4-16	5-20	6-25	8-30	10-40	12-50	16-60	20-60	25-60

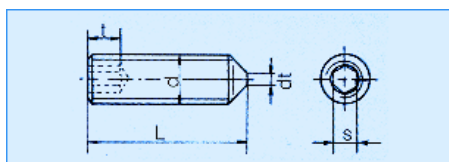
HEXAGON SOCKET SET SCREWS WITH CONE POINT
DIN 914

Thread size	M3	M4	M5	M6	M8	M10	M12	M16	M20
dt	-	-	-	1.5	2	2.5	3	4	5
s	1.5	2	2.5	3	4	5	6	8	10
t	1.2	1.5	2	2	3	4	4.8	6.4	8
L	5-16	6-20	8-25	10-30	12-40	16-50	20-60	25-60	30-60

mm

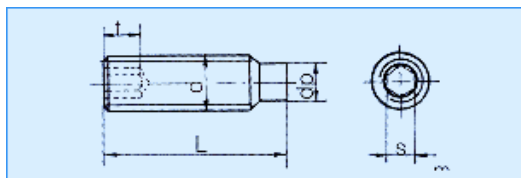
HEXAGON SOCKET SET SCREWS WITH DOG POINT
DIN 915

Thread size	M3	M4	M5	M6	M8	M10	M12	M16	M20
dp	2	2.5	3.5	4	5.5	7	8.5	12	15
s	1.5	2	2.5	3	4	5	6	8	10
t	1.2	1.5	2	2	3	4	4.8	6.4	8
z	short	0.75	1	1.25	1.5	2	2.5	3	4
	Long	1.5	2	2.5	3	4	5	6	8
L	6-16	8-20	10-25	14-30	16-40	20-50	25-60	30-60	35-60

mm

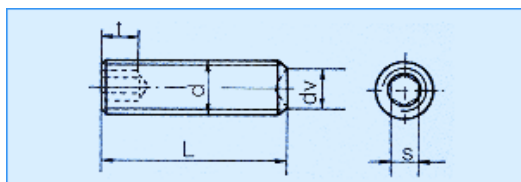
HEXAGON SOCKET SET SCREWS WITH CUP POINT
DIN 916

Thread size	M3	M4	M5	M6	M8	M10	M12	M16	M20
dv	1.4	2	2.5	3	5	6	8	10	14
s	1.5	2	2.5	3	4	5	6	8	10
t	1.2	1.5	2	2	3	4	4.8	6.4	8
L	4-16	5-20	6-25	8-30	10-40	12-50	16-60	20-60	25-60

mm

HEXAGON SOCKET HEAD CAP SCREWS

DIN 912

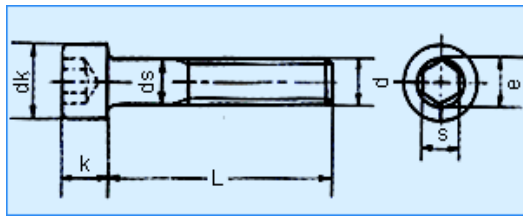

STRENGTH GRADE
8.8
10.9
12.9

mm

Thread size	M3	M4	M5	M6	M8	M10	M12	M14	M16	M20
pitch	0.5	0.7	0.8	1	1.25	1.5	1.75	2	2	2.5
dk	5.32	6.78	8.28	9.78	12.73	15.73	17.73	20.67	23.67	29.67
ds	3	4	5	6	8	10	12	14	16	20
k	2.86	3.82	4.82	5.7	7.64	9.64	11.57	13.57	15.57	19.48
e	2.87	3.44	4.58	5.72	6.86	9.15	11.43	13.72	16	19.44
s	2.5	3	4	5	6	8	10	12	14	17
L	5-30	6-40	8-50	10-60	12-80	16-100	20-120	25-140	25-160	30-200

HEXAGON SOCKET COUNTERSUNK HEAD CAP SCREWS

DIN 7991

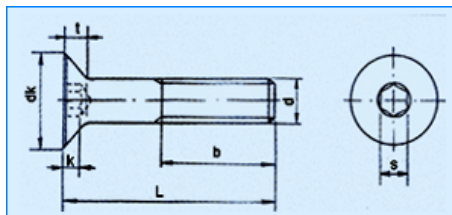

mm

Thread size	M3	M4	M5	M6	M8	M10	M12	M16	M20	
b	L < 125	12	14	16	18	22	26	30	38	46
	125 < L ≤ 200				24	28	32	36	44	52
	L > 200					45	49	57	65	
dk	6	8	10	12	16	20	24	30	36	
k	1.70	2.30	2.80	3.30	4.40	5.50	6.50	7.50	8.50	
s	2.00	2.50	3.00	4.00	5.00	6.00	8.00	10.0	12.0	
t	0.95	1.55	2.05	2.25	3.20	4.10	4.30	5.00	5.60	
L	8-30	8-40	10-50	12-50	16-60	20-70	25-70	35-90	40-100	

TURNBUCKLE WITH HOOK AND EYE

DIN 1480

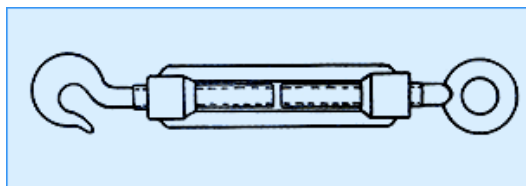

mm

SIZE AVAILABLE										
THREAD SIZE	6X10	8X110	10X12	12X12	14X14	16X17	20X20	22X22	24X25	30X25

LIFTING EYE BOLTS

DIN 580

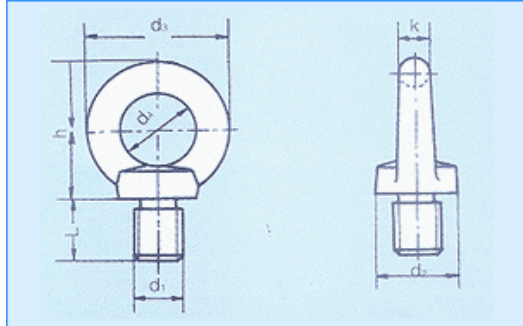

mm

d1	M8	M10	M12	M16	M20	M24	M30	M36
d2	20	25	30	35	40	50	65	75
d3	36	45	54	63	72	90	108	128
d4	20	25	30	35	40	50	60	70
h	36	45	53	62	71	90	109	128
k	8	10	12	14	16	20	24	28
L	13	17	20.5	27	30	36	45	54

EYE BOLTS

DIN 444

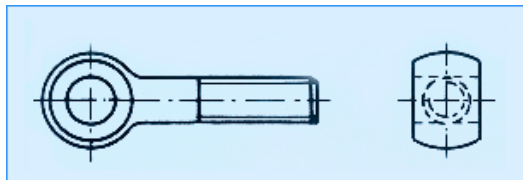

mm

Thread size	M5	M6	M8	M10	M12	M16	M20	M24	M30
Length	30-50	30-60	40-80	50-100	60-120	60-150	65-200	80-200	90-300

ANCHOR BOLTS

DIN 529



mm

Thread size	M8	M10	M12	M16	M20	M24	M30
Length	80-125	111-160	180	200	250	320	400

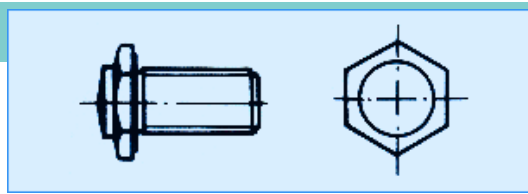

S

Thread size	M8×19
-------------	-------

DRAW BOLTS

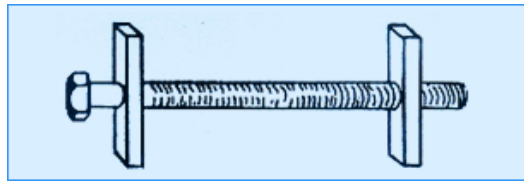

size	1/4-20 × 3-1/2	1/4-20 × 4
------	----------------	------------

ACOUSTICAL TOGGLES

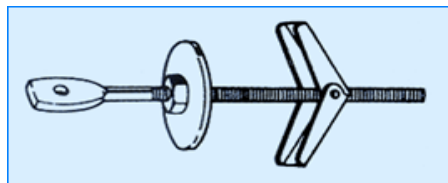

size	1/4-20 × 4-1/4
------	----------------

NUTS

HEXAGON NUTS

DIN 555

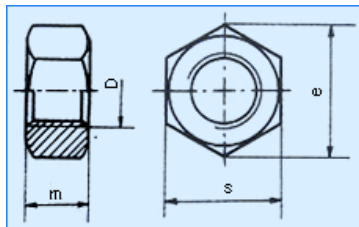

Thread size	M5	M6	M8	M10	M12	M16	M20	M24	M30	M36	M42	M48	M56
Pitch	0.8	1	1.25	1.5	1.75	2	2.5	3	3.5	4	4.5	5	5.5
m	4	5	6.5	8	10	13	16	19	24	29	34	38	45
e	8.63	10.89	14.2	18.72	20.88	26.17	32.95	39.55	50.85	60.79	71.3	82.6	93.56
s	8	10	13	17	19	24	30	36	46	55	65	75	85

mm

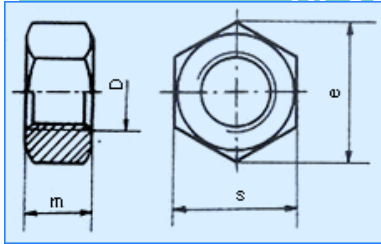
HEXAGON NUTS
DIN 934

mm

Thread size	M2	M3	M4	M5	M6	M8	M10	M12	M16
Pitch	0.4	0.5	0.7	0.8	1	1.25	1.5	1.75	2
m	1.6	2.4	3.2	4	5	6.5	8	10	13
e	4.32	6.01	7.66	8.79	11.05	14.38	18.9	21.1	16.75
s	4	5.5	7	8	10	13	17	19	24
Thread size	M20	M24	M30	M36	M42	M48	M56		
Pitch	2.5	3	3.5	4	4.5	5	5.5		
m	16	19	24	29	34	38	45		
e	32.95	39.55	50.85	60.79	71.3	82.6	93.56		
s	30	36	46	55	65	75	85		

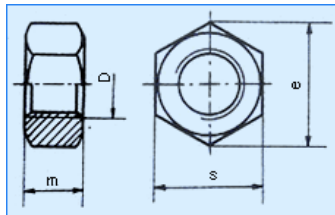
BRIGHT MILD STEEL HEX NUTS
B.S. 1083

inches

Thread size	1/8	5/32	3/16	1/4	5/16	3/8	7/16	1/2
Pitch	40	32	24	20	18	16	14	12
s	5.59	7.6	8.23	11.30	13.34	15.24	18.03	20.83
e	6.40	8.20	9.50	13.00	15.30	17.50	20.70	24.10
m	3.04	3.88	4.24	5.08	6.35	7.92	9.53	11.10

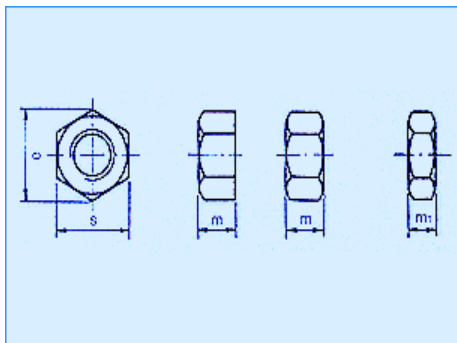

inches

Thread size	1/4	5/16	3/8	7/16	1/2	9/16	5/8	3/4	7/8
e	0.505	0.577	0.650	0.794	0.866	1.010	1.083	1.300	1.515
s	0.437	0.500	0.562	0.687	0.750	0.875	0.937	1.125	1.312
m	0.224	0.271	0.333	0.380	0.442	0.489	0.552	0.651	0.760
m1	0.286	0.333	0.411	0.458	0.567	0.614	0.724	0.822	0.916
m2	0.161	0.192	0.224	0.255	0.317	0.349	0.380	0.432	0.494
Thread size	1	1 1/8	1 1/4	1 3/8	1 1/2	1 3/4	2		
e	1.732	1.948	2.165	2.382	2.598	3.031	3.461		
s	1.500	1.687	1.875	2.062	2.250	2.625	3.000		
m	0.874	0.989	1.087	1.197	1.311	1.530	1.754		
m1	1.015	1.176	1.275	1.400	1.530	-	-		
m2	0.562	0.629	0.744	0.806	0.874	0.999	1.129		

HEXAGON NUTS

B.S. 1769

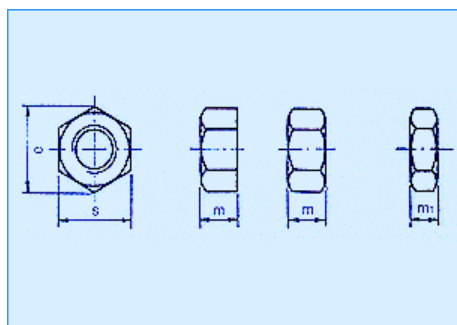

inches

Thread size	1/2	5/8	3/4	7/8	1	1 1/8	1 1/4	1 3/8	1 1/2	1 3/4	2
P UNC	13	11	10	9	8	7	7	6	6	5	4 1/2
P UNF	20	18	16	14	12	12	12	12	12	-	-
e	1.01	1.23	1.44	1.66	1.88	2.09	2.31	2.53	2.74	3.18	3.61
s	0.875	1.062	1.250	1.437	1.625	1.812	2.000	2.187	2.375	2.750	3.125
m	0.520	0.647	0.774	0.901	1.028	1.155	1.282	1.409	1.536	1.790	2.044
m1	0.332	0.397	0.462	0.526	0.590	0.655	0.782	0.846	0.911	1.040	1.169

HEXAGON NUTS

AS1112

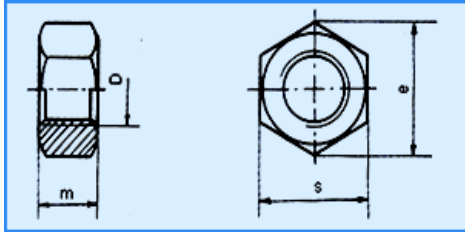

mm

Thread size	M2	M3	M4	M5	M6	M8	M10	M12	M16
Pitch	0.4	0.5	0.7	0.8	1.0	1.25	1.5	1.75	2.0
s	1.6	2.4	3.2	4.7	5.2	6.8	8.4	10.8	14.8
e	4.32	6.01	7.66	8.79	11.05	14.38	17.77	20.03	26.75
s	4	5.5	7	8	10	13	16	18	24
Thread size	M20	M24	M30	M36	M42	M48	M56		
Pitch	2.5	3.0	3.5	4.0	4.5	5.0	5.5		
s	18	21.5	25.6	31	34.8	38.8	45.8		
e	32.95	39.55	50.85	60.79	71.30	82.60	93.50		
s	30	36	46	55	65	75	85		

HEXAGON NUTS

ISO 4032

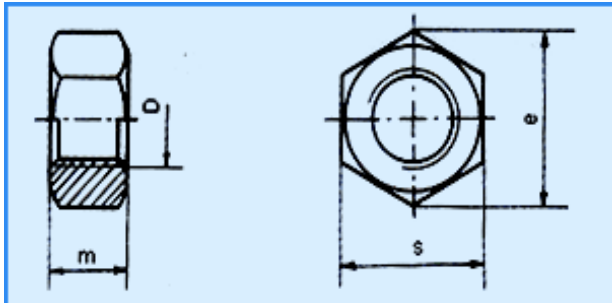

mm

Thread size	M2	M3	M4	M5	M6	M8	M10	M12	M16
Pitch	0.4	0.5	0.7	0.8	1	1.25	1.5	1.75	2
m	1.6	2.4	3.2	4.7	5.2	6.8	8.4	10.8	14.8
e	4.32	6.01	7.66	8.79	11.05	14.38	17.77	20.03	26.75
s	4	5.5	7	8	10	13	16	18	24
Thread size	M20	M24	M30	M36	M42	M48	M56		
Pitch	2.5	3	3.5	4	4.5	5	5.5		
m	18	21.5	25.6	31	34	38	45		
e	32.95	39.55	50.85	60.79	71.3	82.6	93.56		
s	30	36	46	55	65	75	85		

HEXAGON NUTS

ISO 4033

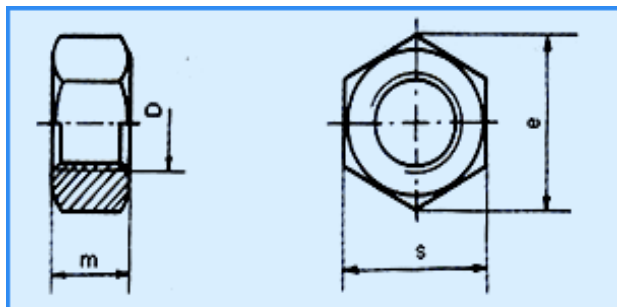

Thread size	M5	M6	M8	M10	M12	M16	M20	M24	M30	M36
Pitch	0.8	1	1.25	1.5	1.75	2	2.5	3	3.5	4
m	5.1	5.7	7.5	9.3	12	16.4	20.3	23.9	28.6	34.7
e	8.79	11.05	14.38	17.77	20.03	26.75	32.95	39.55	50.85	60.79
s	8	10	13	16	18	24	30	36	46	55

mm

HEXAGON NUTS

ISO 4034

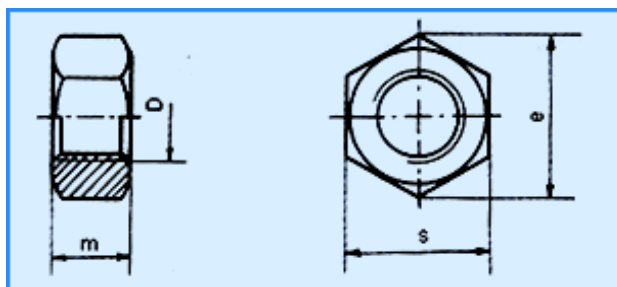

Thread size	M5	M6	M8	M10	M12	M16	M20	M24	M30	M36
Pitch	0.8	1	1.25	1.5	1.75	2	2.5	3	3.5	4
m	5.6	6.1	7.9	9.5	12.2	15.9	19	22.3	26.4	31.5
e	8.63	10.89	14.20	17.59	19.85	26.17	32.95	39.55	50.85	60.79
s	8	10	13	16	18	24	30	35	45	53.8

mm

HEXAGON THIN NUTS

ISO 4035

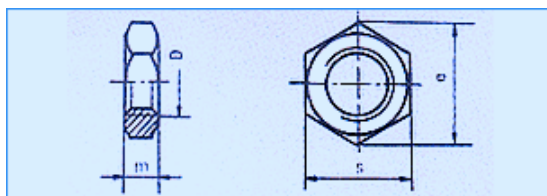

Thread size	M10	M12	M14	M22
Pitch	1.5	1.75	2	2.5
m	5	6	7	11
e	17.77	20.03	23.35	37.29
s	16	18	21	24

mm

HEXAGON NUTS

UNI 5587

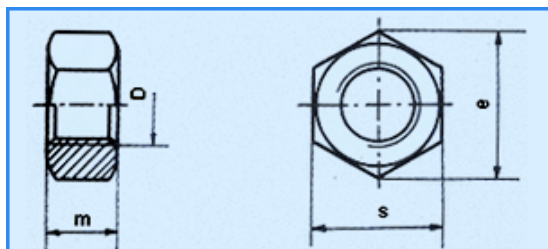

Thread size	M3	M4	M5	M6	M8	M10	M12	M16	M20	M24	M30	mm
m	3	4	5	6	8	10	12	16	20	24	30	
e	6.08	7.74	8.87	11.05	14.38	18.90	21.10	26.75	33.53	39.98	51.29	
s	5.5	7	8	10	13	17	19	24	30	36	46	

CHAMFERED HEXAGON THIN NUTS

DIN 439

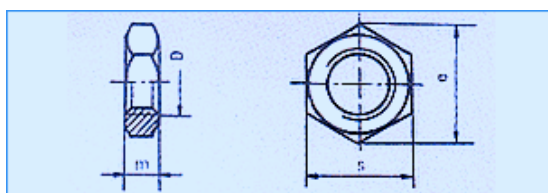

Thread size	M3	M4	M5	M6	M8	M10	M12	M16	M20	M24	M30	M36	M42	M48	mm
Pitch	0.5	0.7	0.8	1	1.25	1.5	1.75	2	2.5	3	3.5	4	4.5	5	
m	1.8	2.2	2.7	3.2	4	5	6	8	10	12	15	18	21	24	
e	6.01	7.66	8.79	11.05	14.38	18.9	21.1	26.75	32.95	39.55	50.85	60.79	71.3	82.6	
s	5.5	7	8	10	13	17	19	24	30	36	46	55	65	75	

HEXAGON THIN NUTS

DIN 936

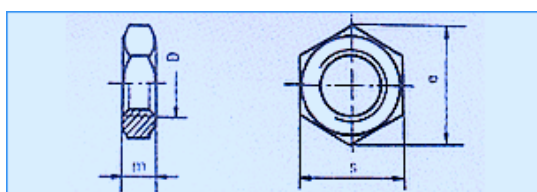

Thread size	M8	M10	M12	M16	M20	M24	M30	M36	M42	M48	mm
Pitch	1.25	1.5	1.75	2	2.5	3	3.5	4	4.5	5	
m	5	6	7	8	9	10	12	14	16	18	
e	14.38	18.90	21.1	26.75	32.95	39.55	50.85	60.79	71.3	82.6	
s	13	17	19	24	30	36	46	55	65	75	

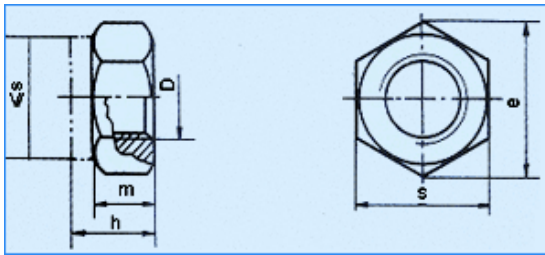
ALL-METAL PREVALLING TORQUE TYPE HEXAGON NUTS
DIN 980

mm

Thread size	M5	M6	M8	M10	M12	M14	M16	M18	M20
Pitch	0.8	1	1.25	1.5	1.75	2	2	2.5	2.5
h	5.1	6	8	10	12	14	16	18	20
e	8.79	11.05	14.38	18.9	21.1	24.49	26.75	29.56	32.95
s	8	10	13	17	19	22	24	27	30

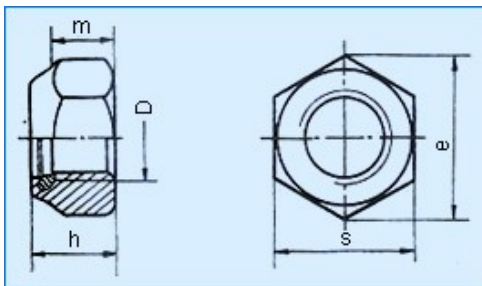
**PREVALLING TORQUE TYPE
HEXAGON THIN NUTS WITH NONMETALLIC INSERT**
DIN 985

mm

Thread size	M5	M6	M8	M10	M12	M14	M16	M18	M20
Pitch	0.8	1	1.25	1.5	1.75	2	2	2.5	2.5
h	5	6	8	10	12	14	16	18.5	20
m	3.2	4	5.5	6.5	8	9.5	10.5	13	14
e	8.79	11.05	14.38	18.9	21.1	24.49	26.75	29.56	32.95
s	8	10	13	17	19	22	24	27	30

HEX CONNECTING NUTS
DIN 6334

Thread size	M6	M8	M10	M12	M16
-------------	----	----	-----	-----	-----

HEXAGON WELD NUTS

DIN 929

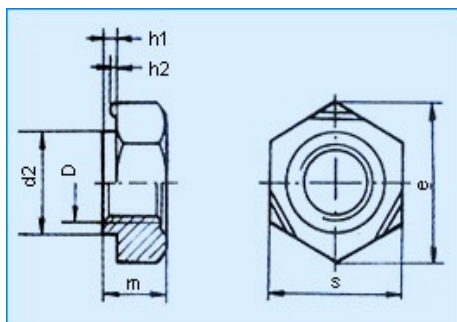

mm

Thread size	M4	M5	M6	M8	M10	M12	M16
m	3.5	4	5	6.5	8	10	13
e	9.83	10.95	12.02	15.38	18.74	20.91	26.51
s	9	10	11	14	17	19	24
h ₁	0.65	0.7	0.75	0.9	1.15	1.4	1.8
h ₂	0.35	0.4	0.4	0.5	0.65	0.8	1
d ₂	6	7	8	10.5	12.5	14.8	18.8

HEXAGON NUTS WITH FLANGE

DIN 6923

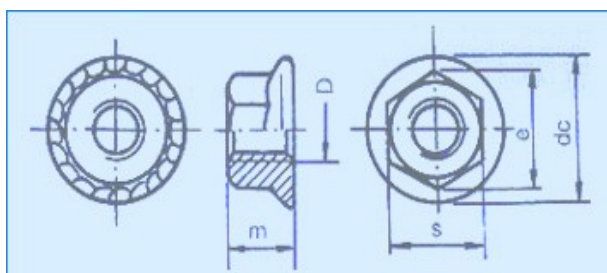

mm

Thread size	M5	M6	M8	M10	M12	M14	M16	M20
Pitch	0.8	1	1.25	1.5	1.75	2	2	2.5
m	5	6	8	10	12	14	16	20
e	8.79	11.05	14.38	16.64	20.03	23.36	26.75	32.95
s	8	10	13	15	18	21	24	30
dc	11.8	14.2	17.9	21.8	26	29.9	34.5	42.8

HEXAGON SLOTTED NUTS

DIN 935

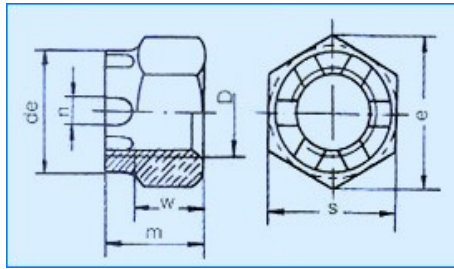

mm

Thread size	M6	M8	M10	M12	M16	M20	M24	M30	M36
m	7.5	9.5	12	15	19	22	27	33	38
e	11.05	14.38	17.77	20.03	26.75	32.95	39.55	50.85	60.79
s	10	13	16	18	24	30	36	46	55
n	2	2.5	2.8	3.5	4.5	4.5	5.5	7	7
w	5	6.5	8	10	13	16	19	24	29
de	-	-	-	16	22	28	34	42	50

HEXAGON THIN SLOTTED NUTS

DIN 937

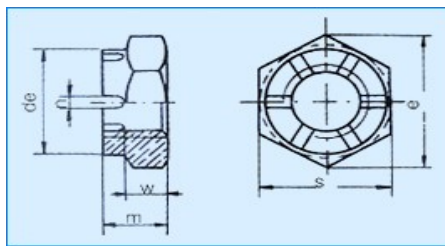

mm

Thread size	M6	M8	M10	M12	M16	M20	M24	M30	M36
m	6	8	9	10	12	13	15	18	20
e	11.05	14.38	18.9	20.1	26.75	32.95	35.55	50.85	60.79
s	10	13	17	19	24	30	36	46	55
n	2	2.5	2.8	3.5	4.5	4.5	5.5	7	7
w	3.5	4.5	5	6	7	8	9	11	13
de	-	-	-	17	22	28	33	41	49

HEXAGON THIN SLOTTED NUTS

DIN 979

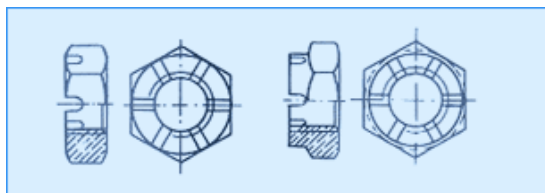

mm

Thread size	M6	M8	M10	M12	M16	M20	M24	M30	M36
m	5	6.5	8	10	13	16	19	24	29
e	11.05	14.38	17.77	20.03	26.75	32.95	39.55	50.85	60.79
s	10	13	16	18	24	30	36	46	55
n	2	2.5	2.8	3.5	4.5	4.5	5.5	7	7
w	2.5	3.5	4	5	7	10	11	15	20
de	-	-	-	16	22	28	34	42	50

HEXAGON CAP NUTS

DIN 917

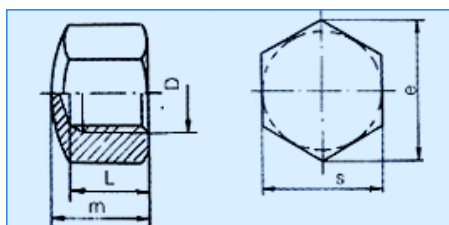

mm

Thread size	M4	M5	M6	M8	M10	M12	M16	M20	M24
m	5.5	7	9	12	14	16	20	25	30
e	7.66	8.79	11.05	14.38	17.77	20.03	26.75	32.95	39.55
s	7	8	10	13	16	18	24	30	36
L	4.16	4.96	6.71	9.21	10.65	13.15	16.65	20.58	23.58

HEXAGON DOMED CAP NUTS

DIN 986

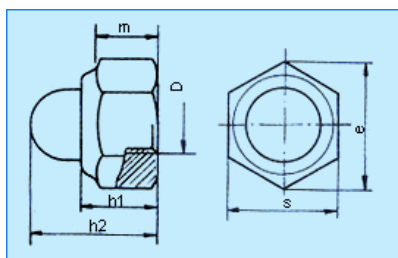

mm

Thread size	M4	M5	M6	M8	M10	M12	M16	M20
m	2.9	4.4	4.9	6.44	8.04	10.37	14.1	16.9
e	7.66	8.79	11.05	14.38	18.9	21.1	26.75	32.95
s	7	8	10	13	16	18	24	30
h ₁	5.6	6	7.5	8.9	10.5	13.5	16.5	21
h ₂	9.6	10.5	12	14	18.1	22.5	27.5	35

HEXAGON DOMED CAP NUTS

DIN 1587

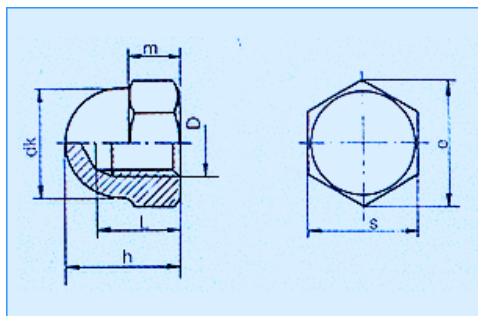

Thread size	M4	M5	M6	M8	M10	M12	M16	M20	M24
m	3.2	4	5	6.5	8	10	13	16	19
e	7.66	8.79	11.05	14.38	17.77	20.03	26.75	33.53	39.98
s	7	8	10	13	16	18	24	30	36
h	8	10	12	15	18	22	28	34	42
L	5.26	7.21	7.71	10.65	12.65	15.65	20.58	25.58	30.5
dk	6.5	7.5	9.5	12.5	15	17	23	28	34

mm

WING NUTS

DIN 315

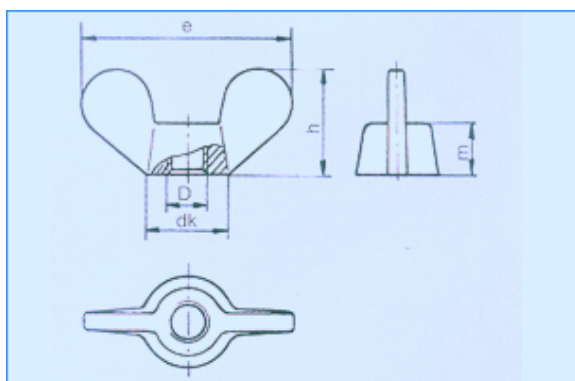

Thread size	M4	M5	M6	M8	M10	M12	M16	M20	M24
Pitch	0.7	0.8	1	1.25	1.15	1.75	2	2.5	3
dk	6	8	10	13	17	20	26	32	41
e	18	24	30	36	48	62	70	86	106
h	8.5	11	15	18	23	31	35	44	53.5
m	3.2	4	5	6.5	8	10	13	16	20

mm

SQUARE THIN NUTS

DIN 562

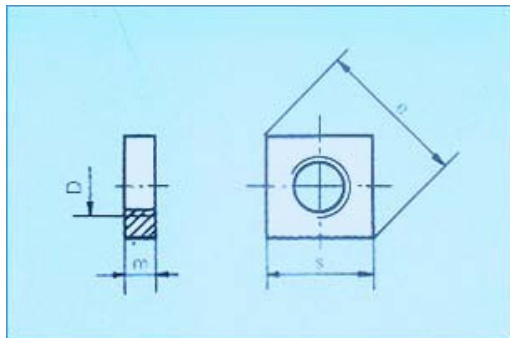

Thread size	M2	M3	M4	M5	M6	M8	M10	
Pitch	0.4	0.5	0.7	0.8	1	1.25	1.5	
m	1.2	1.8	2.2	2.7	3.2	4	5	
e	5	7	8.9	10.2	12.7	16.5	20.2	21.5
s	4	5.5	7	8	10	13	16	17

mm

SQUARE NUTS

DIN 928

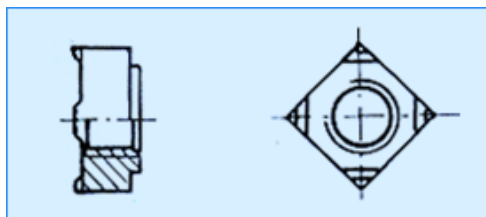

Thread size	M4	M5	M6	M8	M10	M12

mm

SQUARE NUTS

DIN 557

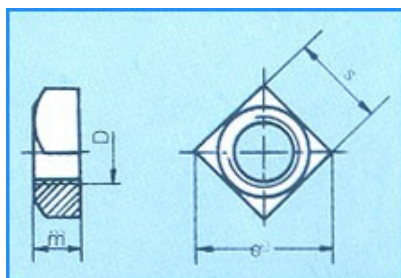

Thread size	M5	M6	M8	M10		M12		M16	M20
Pitch	0.8	1	1.25	1.5		1.75		2	2.5
m	4	5	6.5	8		10		13	16
e	11.3	14.1	18.4	22.6	24	25.4	26.9	32.9	42.4
s	8	10	13	16	17	18	19	24	30

mm

SQUARE NUTS

B.S.

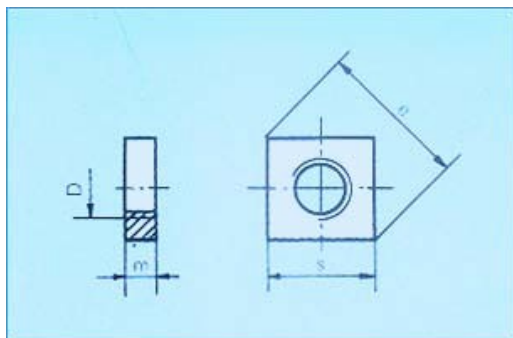

Thread size	1/8	5/32	3/16	1/4
Thread per inch	40	32	24	20
m	2.13	2.74	3.12	3.38
e	7.9	10.1	11.6	15.9
s	5.59	7.16	8.23	11.30

inches

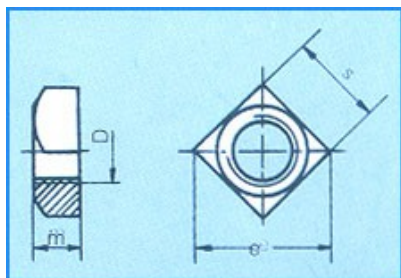

Thread size	3/16	1/4	5/16	3/8	7/16	1/2
Thread per inch	24	20	18	16	14	12
m	4.24	5.08	6.35	7.92	9.53	11.10
e	11.6	15.9	18.9	21.5	25.4	29.4
s	8.23	11.3	13.34	15.24	18.03	20.83

inches

TEE NUTS WITH PRONGES

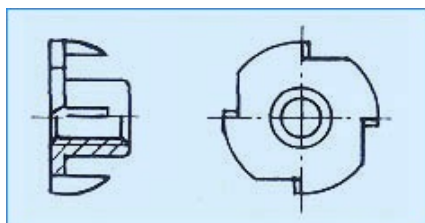

Thread size	M3	M4	M5	M6	M8	M10
-------------	----	----	----	----	----	-----

LOCK NUTS

DIN 7967

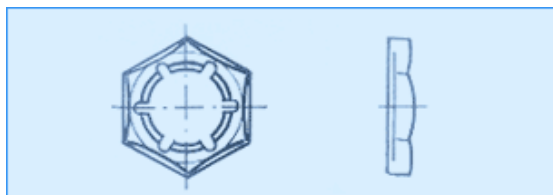

For thread	M3	M4	M5	M6	M8	M10	M12	M14	M16	M18
For thread	M20	M22	M24	M27	M30	M33	M36	M39	M42	

LOCK NUTS

DIN 582

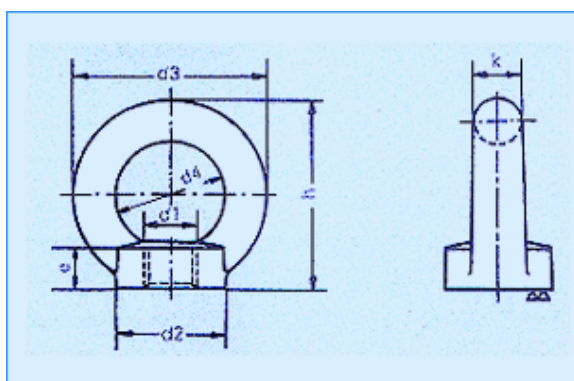

	mm							
d1	M8	M10	M12	M16	M20	M24	M30	M36
d2	20	25	30	35	40	50	65	75
d3	36	45	54	63	72	90	108	126
d4	20	25	30	35	40	50	60	70
e	8.5	10	11	13	16	20	25	30
h	36	45	53	62	71	90	109	128
k	8	10	12	14	16	20	24	28

EYE COUPLING NUTS

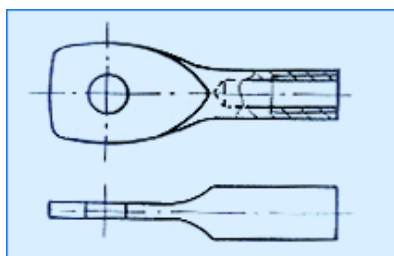

Thread size	M6
-------------	----

ANCHOR NUTS

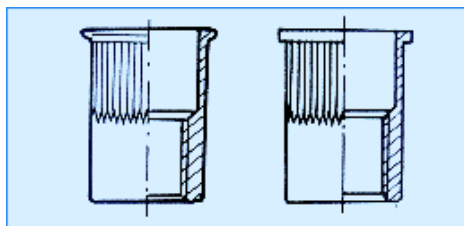

Thread size	M3	M4	M5	M6	M8	M10
-------------	----	----	----	----	----	-----

WASHERS

WASHERS (Grade A)

DIN 125

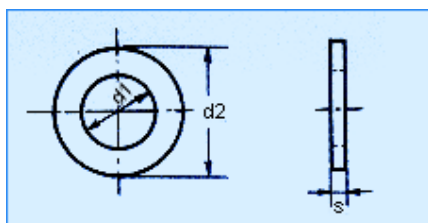

	mm										
d1	1.7	1.8	2.2	2.5	2.7	2.8	3.2	3.7	4.3	5.3	6.4
d2	4	4.5	5	6	6	7	7	8	9	10	12
s	0.3	0.3	0.3	0.5	0.5	0.5	0.5	0.5	0.8	1	1.6
d1	7.4	8.4	10.5	13	15	17	19	21	23	23	
d2	14	16	20	24	28	30	34	37	39	39	
s	1.6	1.6	2	2.5	2.5	3	3	3	3	3	

WASHERS (Grade C)

DIN 126

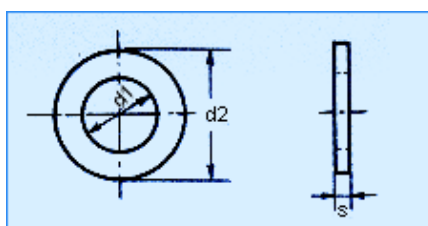

	mm										
d1	5.5	6.6	7.6	9	11	13.5	15.5	17.5	20	22	24
d2	10	12.5	14	16	20	24	28	30	34	37	39
s	1	1.6	1.6	1.6	2	2.5	2.5	3	3	3	3
d1	26	30	33	36	39	42	45	48	52	56	
d2	44	50	56	60	66	72	78	85	92	98	
s	4	4	4	5	5	6	7	7	8	8	

SQUARE BEVELED WASHERS

DIN 434



For screws M8 M10 M12 M16 M20 M22 M24 M27

SQUARE BEVELED WASHERS

DIN 435

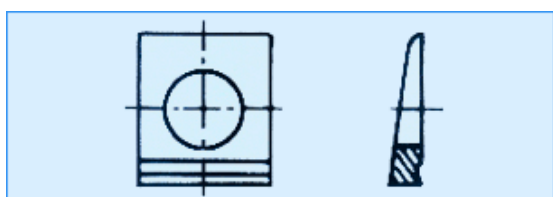

For screws M8 M10 M12 M16 M20 M22 M24 M27 M30

SPRING LOCK WASHERS

DIN 127

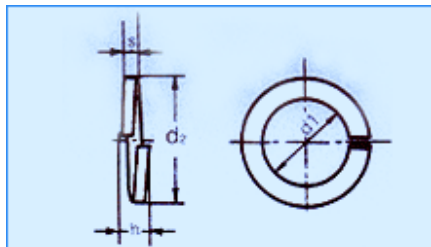

	mm									
Nominal size	3	3.5	4	5	6	7	8	10	12	
d1	3.4	3.9	4.4	5.4	6.5	7.5	8.5	10.7	12.7	
d2	6.2	6.7	7.6	9.2	11.8	12.8	14.8	18.1	21.1	
h	1.9	1.9	2.1	2.8	3.8	3.8	4.7	5.2	5.9	
s	0.8	0.8	0.9	1.2	1.6	1.6	2	2.2	2.5	
Nominal size	14	16	18	20	22	24	27	30		
d1	14.7	17	19	21.2	23.5	25.5	28.5	31.7		
d2	24.1	27.4	29.4	33.6	35.9	40	43	48.2		
h	7.1	8.3	8.3	9.4	9.4	11.8	11.8	14.2		
s	3	3.5	3.5	4	4	5	5	6		

SPRING LOCK WASHERS

B.S.

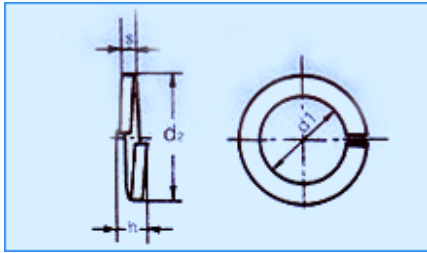

inches

Nominal	1/8	5/32	3/16	1/4	5/16	3/8	7/16	1/2	9/16
d1	0.133	0.164	0.196	0.266	0.328	0.391	0.453	0.516	0.601
b	0.053	0.061	0.075	0.108	0.130	0.142	0.161	0.173	0.189
h	0.067	0.083	0.098	0.142	0.165	0.189	0.220	0.244	0.283
s	0.033	0.041	0.049	0.071	0.083	0.094	0.110	0.122	0.142
Nominal	5/8	3/4	7/8	1	1 1/8	1 1/4	1 1/2		
d1	0.656	0.781	0.906	1.031	1.156	1.281	1.531		
b	0.213	0.248	0.276	0.291	0.307	0.331	0.354		
h	0.303	0.354	0.394	0.433	0.472	0.504	0.551		
s	0.152	0.177	0.197	0.217	0.236	0.252	0.276		

MACHINE SCREWS

GALVANIZED ROOFING BOLTS & NUTS

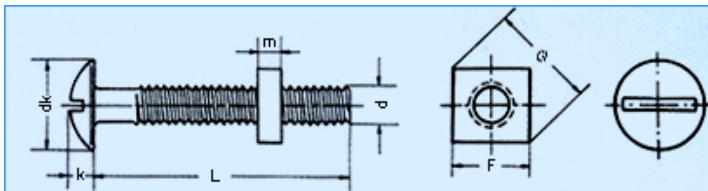

inches

Thread size	dk	k	m	F	G	L
3/6	10	2.3	3.048	8.128	11.684	3/16-3
1/4	13.3	3	0.302	11.176	16.002	1/2-5

SLOTTED CHEESE HEAD SCREWS

DIN 84

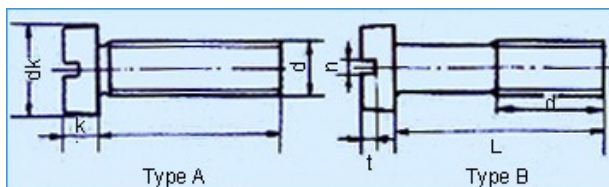

mm

Thread size	M3	M3.5	M4	M5	M6	M8	M10
dk	5.5	6	7	8.5	10	13	16
k	2	2.4	2.6	3.3	3.9	5	6
L	A	6-22	6-22	8-25	8-28	10-35	14-40
	B	25-30	25-35	28-40	30-50	40-60	45-80

SLOTTED PAN HEAD SCREWS

DIN 85

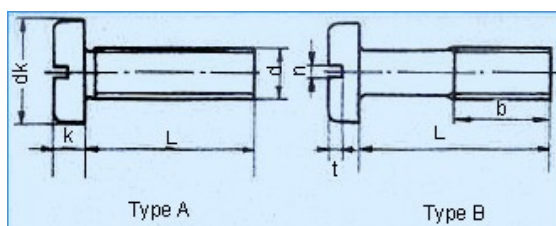

mm

Thread size	M3	M3.5	M4	M5	M6	M8	M10
dk	6	7	8	10	12	16	20
k	1.8	2.1	2.4	3	3.6	4.8	6
L	A	6-22	6-22	8-25	8-28	10-35	14-40
	B	25-30	25-35	28-40	30-50	40-60	45-80

SLOTTED COUNTERSUNK HEAD SCREWS

DIN 963

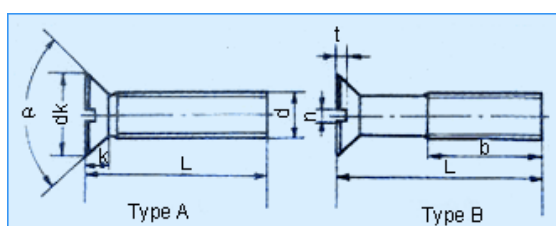

mm

Thread size	M3	M3.5	M4	M5	M6	M8	M10
dk	5.6	6.5	7.5	9.2	11	14.5	18
k	1.65	1.93	2.2	2.5	3	4	5
L	A	6-22	6-22	8-25	8-28	10-35	14-40
	B	25-30	25-35	28-40	30-50	40-60	45-80

SLOTTED RAISED COUNTERSUNK HEAD SCREWS

DIN 964

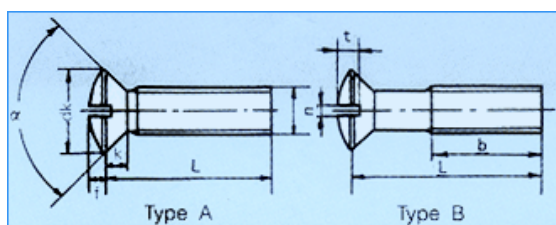

mm

Thread size	M3	M3.5	M4	M5	M6	M8	M10
dk	5.6	6.5	7.5	9.2	11	14.5	18
k	1.65	1.93	2.2	2.5	3	4	5
f	0.75	0.9	1	1.25	1.5	2	2.5
L	A	6-22	6-22	8-25	8-28	10-35	14-40
	B	25-30	25-35	28-40	30-50	40-60	45-80



ROOFING BOLTS & NUTS

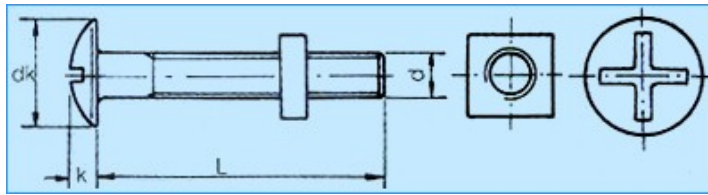

mm

Thread size	M4	M5	M6	M8
dk	9.4	11.6	13.95	18.9
k	1.90	2.65	3.33	3.80
L	10-50	10-80	12-120	16-150

CROSS RECESSED RAISED CHEESE HEAD SCREWS

DIN 7985

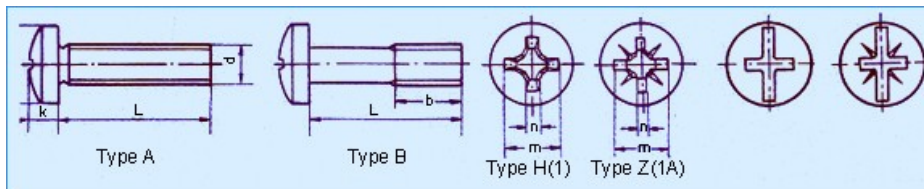

mm

Thread size	M3	M3.5	M4	M5	M6	M8	M10
dk	6	7	8	10	12	16	20
k	2.4	2.7	3.1	3.8	4.6	6	7.5
Cross recesses	(Type H)m	3.1	4.2	4.6	5.3	6.8	10.2
	(Type Z)m	3	4	4.3	5	6.7	9.9
	No	1	2	2	2	3	4
L	Type A	6-22	6-22	8-25	8-28	10-35	14-40
	Type B	25-30	25-35	28-40	30-50	40-60	45-80

CROSS RECESSED COUNTERSUNK FLAT HEAD SCREWS

DIN 965

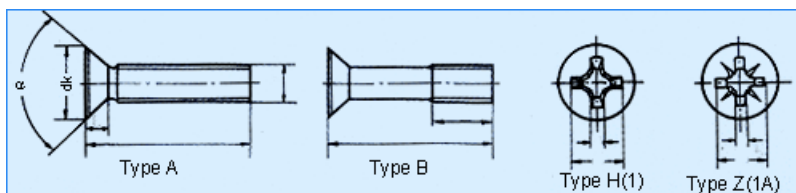

mm

Thread size	M3	M3.5	M4	M5	M6	M8	M10
dk	5.6	6.5	7.5	9.2	11	14.5	18
k	1.65	1.93	2.2	2.5	3	4	5
Cross	(Type H)m	2.9	3.9	4.4	4.6	6.6	9.6
	(Type Z)m	2.8	3.7	4	4.4	6.1	9.4
	No	1	2	2	2	3	4
L	Type A	6-22	6-22	8-25	8-28	10-35	14-40
	Type B	25-30	25-35	28-40	30-50	40-60	45-80

CROSS RECESSED RAISED COUNTERSUNK HEAD SCREWS

DIN 966

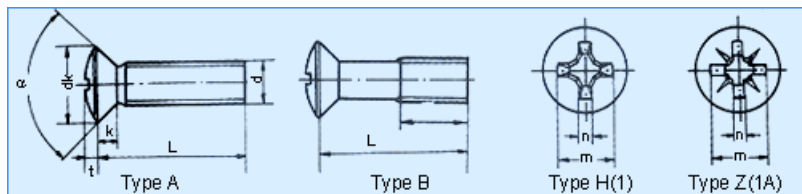

Thread size		M3	M3.5	M4	M5	M6	M8	M10
dk		5.6	6.5	7.5	9.2	11	14.5	18
k		1.65	1.93	2.2	2.5	3	4	5
f		0.75	0.9	1	1.25	1.5	2	2.5
Cross	(Type H)m	3.1	4.2	4.5	5.3	6.8	9	10
	(Type Z)m	3.1	4.3	4.6	5.3	7	8.8	9.9
	NO	1	2	2	2	3	4	4
L	Type A	6-22	6-22	8-25	8-28	10-35	14-40	18-45
	Type B	25-30	25-35	28-40	30-50	40-60	45-80	50-100

WOOD SCREWS

SLOTTED COUNTERSUNK HEAD WOOD SCREWS

DIN 97

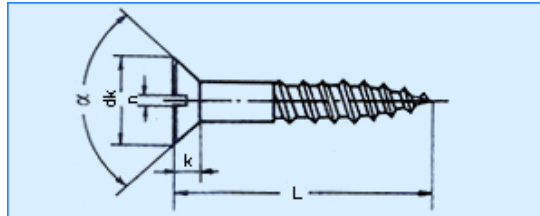

Thread size		2.5	3	3.5	4	4.5	5	5.5	6
dk		4.7	5.6	6.5	7.5	8.3	9.2	10.2	11
k		1.5	1.65	1.93	2.2	2.35	2.5	2.75	3
n		0.6	0.8	0.8	1	1	1.2	1.2	1.6
L		8-25	10-40	12-40	16-50	20-60	20-100	30-100	40-100

SLOTTED ROUND HEAD WOOD SCREWS

DIN 96

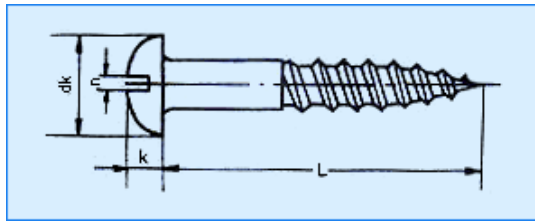

Thread size	2.5	3	3.5	4	4.5	5	5.5	6
dk	5	6	7	8	9	10	11	12
K	1.7	2.1	2.4	2.8	3.1	3.5	3.8	4.2
n	0.6	0.8	0.8	1	1	1.2	1.2	1.6
L	8-25	10-40	12-40	16-50	20-60	20-100	30-100	40-100

mm

FLAT COUNTERSUNK HEAD WOOD SCREWS

DIN 7997

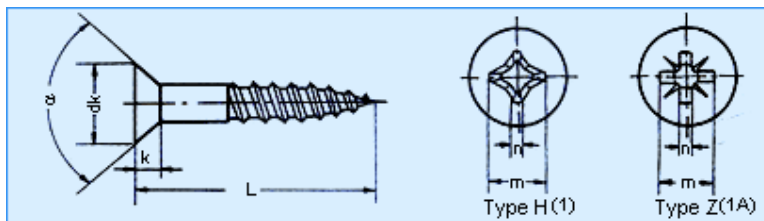

Thread size	2.5	3	3.5	4	4.5	5	5.5	6
dk	4.7	5.6	6.5	7.5	8.3	9.2	10.2	11
k	1.5	1.65	1.93	2.2	2.35	2.5	2.75	3
Cross recess	(Type H) m	2.7	2.9	3.9	4.4	4.6	4.8	6.2
	(Type Z) m	2.8	3	4	4.2	4.4	5	6.1
	No	1	1	2	2	2	3	3
L	10-25	10-40	12-45	16-50	20-60	20-100	30-100	40-100

mm

CROSS RECESSED ROUND HEAD WOOD SCREWS

DIN 7996

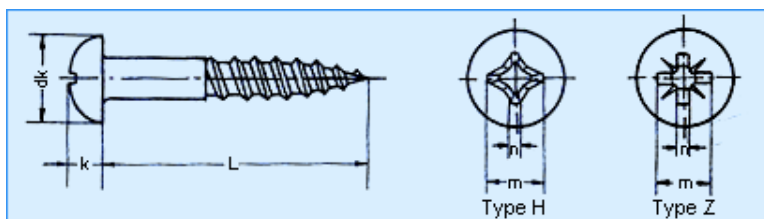

Thread size	2.5	3	3.5	4	4.5	5	5.5	6
dk	5	6	7	8	9	10	11	12
k	1.7	2.1	2.35	2.8	3.1	3.5	3.8	4.2
Cross	(Type H) m	2.3	2.7	3.7	4.1	4.4	4.8	6.2
	(Type Z) m	2.4	2.9	3.9	4.1	4.3	4.7	6.2
	No	1	1	2	2	2	2	3
L	10-25	10-40	12-40	16-50	20-60	20-100	30-100	40-100

mm

CROSS RECESSED RAISED COUNTERSUNK HEAD WOOD SCREWS

DIN 7995

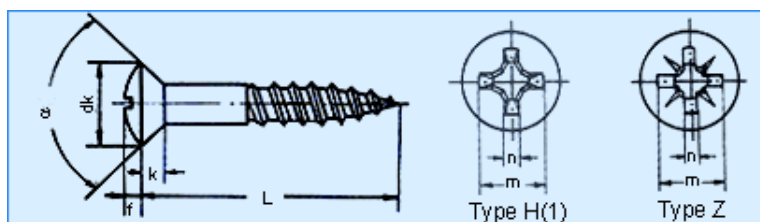

mm

Thread size	2.5	3	3.5	4	4.5	5	5.5	6
dk	4.7	5.6	6.5	7.5	8.3	9.2	10.2	11
f	0.6	0.75	0.9	1	1.1	1.25	1.4	1.5
k	1.5	1.65	1.93	2.2	2.35	2.5	2.75	3
Cross	(Type H) m	2.7	3.1	4.2	4.5	5	5.3	7.1
	(Type Z) m	2.8	3.1	4.3	4.6	5.1	5.3	6.6
No	1	1	2	2	2	3	3	3
L	10-25	10-40	12-40	16-50	20-60	20-100	30-100	40-100

PHILLIPS OVAL HEAD WOOD SCREWS

B.S. 1210

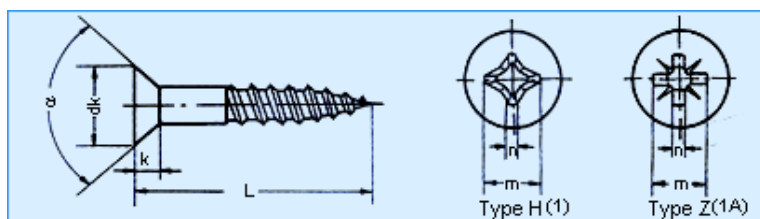

inches

Thread size	4	5	6	7	8	9	10
dk	5.21	5.90	6.58	7.24	7.93	8.59	9.28
f	0.66	0.76	0.81	0.91	1.02	1.17	1.19
k	1.62	1.85	2.08	2.31	2.54	2.76	2.97
Cross recess	(Type Z) m	3.12	3.81	4.32	4.65	5.00	5.28
	NO	1	1	2	2	2	2
L	1/2-1	1/2-1 1/4	1/2-2	3/4-2	3/4-3	3/4-3	3/4-3 1/2

CROSS RECESSED COUNTERSUNK HEAD WOOD SCREWS

B.S. 1210

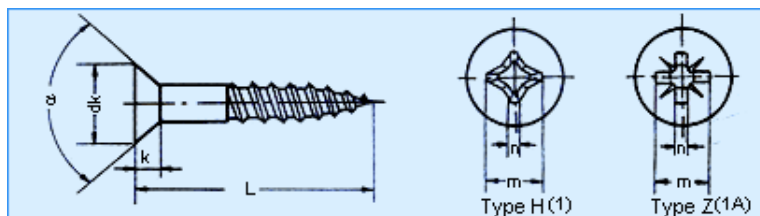

inches

Thread size	3	4	5	6	7	8	9	10	12	14	16
dk	4.55	5.21	5.90	6.56	7.24	7.93	8.59	9.28	10.62	11.99	13.31
k	1.39	1.62	1.88	2.08	2.31	2.54	2.76	2.97	3.42	3.88	4.31
(Type Z) m	2.51	2.74	3.50	4.22	4.22	4.60	4.60	4.98	6.35	6.60	7.49
Cross recess	No	1	1	2	2	2	2	2	3	3	3
	L	1/2-5/8	1/2-2	1/2-1 1/4	1/2-2	3/4-2	3/4-3	3/4-3	3/4-3 1/2	1-5	1 1/2-5

EURO SCREW

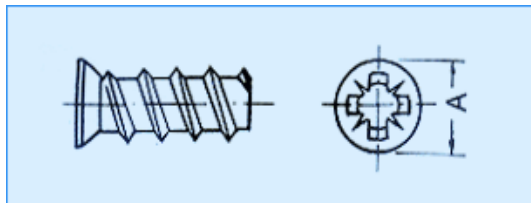

mm

Nominal size	6.3	6.3
Length	9-13	9-13
A	7	8

CONNECTING SCREW FLAT COUNTERSUNK HEAD

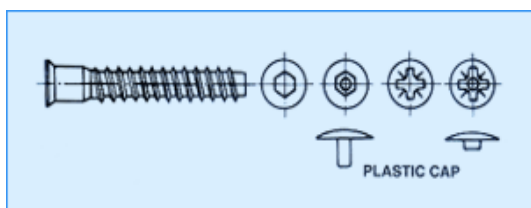

mm

Nominal size	5	7	6.3
Length	40-60	40-80	40-80

JOINT CONNECTOR SCREW FLAT HEAD

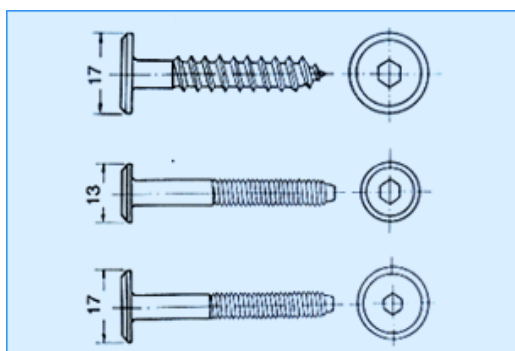

Nominal size	M6-1.0	1/4-20	6.3
Length	20-120	20-120	20-120

JOINT CONNECTOR SCREW ROUND HEAD

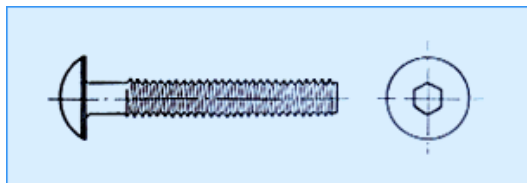

Nominal size	M6-1.0	1/4-20
Length	20-120	20-120

HEXAGON HEAD WOOD SCREWS

DIN 571

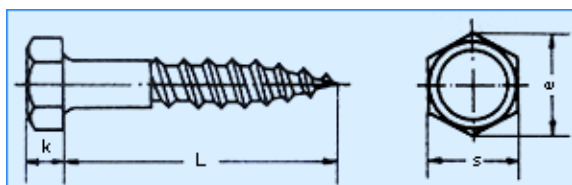

	mm							
Thread size	4	5	6	7	8	10	12	16
k	2.8	3.5	4	5	5.5	7	8	10
e	7.50	8.63	10.89	13.07	14.2	18.72	20.88	26.17
s	7	8	10	12	13	17	19	24
L	16-40	16-50	25-150	30-150	30-200	30-300	35-400	50-420

ACOUSTICALL EYELAGS

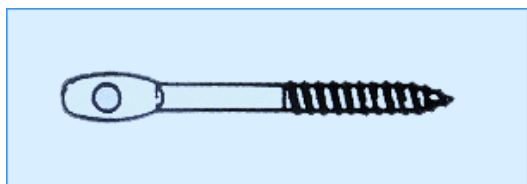

	inches		
Nominal size	1/4 x 3"	1/4 x 4"	1/4 x 5"

METAL WOOD DOWEL SCREW

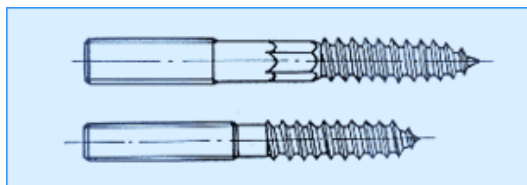

	mm
Nominal size	M8-12
Length	50-200

WOOD-WOOD DOWEL SCREW

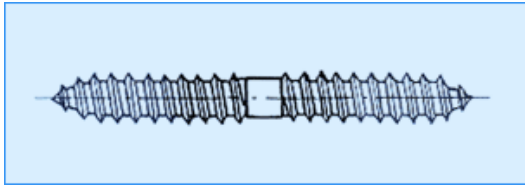

Nominal size	3.5-6.3
Length	25-80

POZIDRIVE TWINFAST WOOD SCREWS

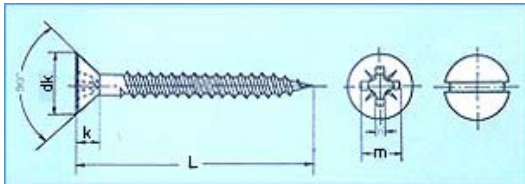

Thread size		4	5	6	7	8	10	12
dk		5.48	6.19	6.90	7.62	8.33	9.75	11.17
k		1.66	1.90	2.13	2.36	2.53	3.01	3.44
n		0.86	1.06	1.06	1.06	1.26	1.26	1.66
cross recess	No	1	2	2	2	2	2	3
	m	2.74	3.50	4.22	4.22	4.60	4.98	6.35
L(in)		1/4-1	5/16-11/4	7/16-2	1/2-21/4	5/8-3	3/4-4	1-4

mm

TAPPING AND CHIPBOARD

PAN HEAD TAPPING SCREWS WITH SLOT

DIN 7971

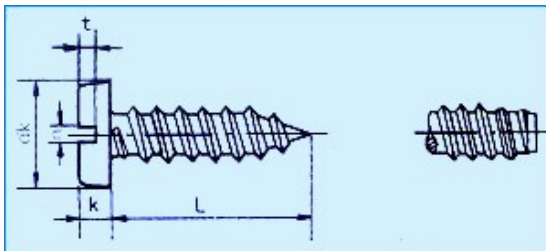

Thread size	2.9	3.5	3.9	4.2	4.8	5.5	6.3
dk	5.6	6.9	7.5	8.2	9.5	10.8	12.5
k	1.5	1.85	2	2.15	2.5	2.85	3.2
m	0.8	1	1	1.2	1.2	1.6	1.6
L(mm)	6.5-25	6.5-50	9.5-50	9.5-63	9.5-63	13-75	13-75

mm

COUNTERSUNK HEAD TAPPING SCREWS WITH SLOT

DIN 7972

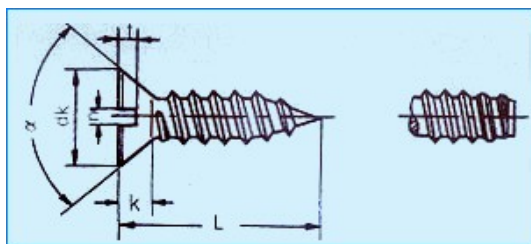

Thread size	2.9	3.5	3.9	4.2	4.8	5.5	6.3
dk	5.5	6.8	7.5	8.1	9.5	10.8	12.4
k	1.7	2.1	2.3	2.5	3	3.4	3.8
n	0.8	1	1	1.2	1.2	1.6	1.6
L	6.5-25	6.5-50	9.5-50	9.5-63	9.5-63	13-75	13-75

mm

RAISED COUNTERSUNK HEAD TAPPING SCREWS WITH SLOT

DIN 7973

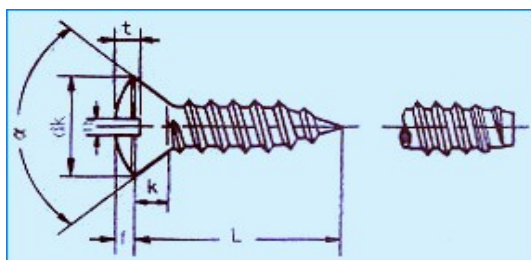

Thread size	2.9	3.5	3.9	4.2	4.8	5.5	6.3
dk	5.5	6.8	7.5	8.1	9.5	10.8	12.5
f	0.9	1.2	1.3	1.4	1.5	1.7	2
k	1.7	2.1	2.3	2.5	3	3.4	3.8
n	0.8	1	1	1.2	1.2	1.6	1.6
L	6.5-25	6.5-50	9.5-50	9.5-63	9.5-63	13-75	13-75

mm

SELF-DRILLING TAPPING SCREWS

DIN 7504

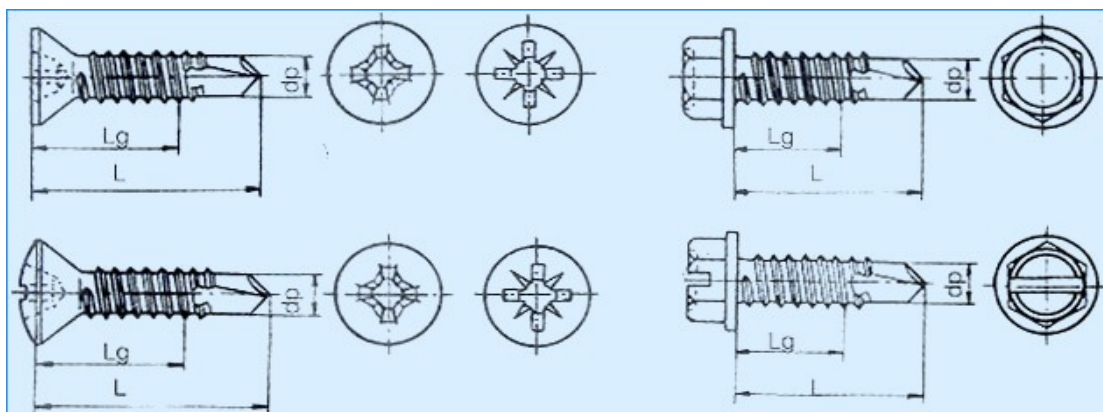

Thread size	ST2.9	ST3.5	ST4.2	ST4.8	ST5.5	ST6.3
dp	2.3	2.8	3.6	4.1	4.8	5.8
Lg	12.5	18.1	29.0	39.5	8-39	7-38
L	6.5-25	6.5-50	9.5-50	9.5-63	13-75	13-75

mm

CROSS RECESSED PAN HEAD TAPPING SCREWS

DIN 7981

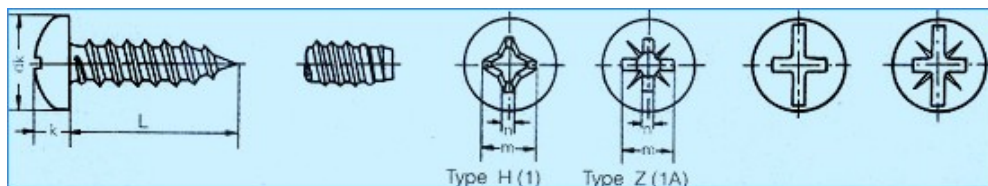

		mm						
Thread size		2.9	3.5	3.9	4.2	4.8	5.5	6.3
Pitch		5.6	6.9	7.5	8.2	9.5	10.8	12.5
k		2.2	2.6	2.8	3.05	1.55	3.95	4.55
Cross recess	(Type H)m	3	4.2	4.4	4.6	5	6.5	7.1
	(Type Z)m	2.9	3.9	4.1	4.3	4.7	6.2	6.7
	No	1	1	2	2	2	3	3
L		6.5-25	6.5-50	9.5-50	9.5-63	9.5-63	13-75	13-75

CROSS RECESSED COUNTERSUNK HEAD TAPPING SCREWS

DIN 7982

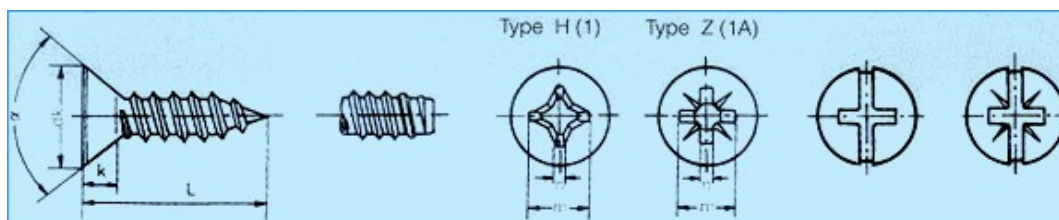

		mm						
Thread size		2.9	3.5	3.9	4.2	4.8	5.5	6.3
dk		5.5	6.8	7.5	8.1	9.5	10.8	12.4
k		1.7	2.1	2.3	2.5	3	3.4	3.8
Cross recess	(Type H) m	3	4.2	4.6	4.7	5.1	5.8	7.1
	(Type Z) m	2.8	4	4.2	4.4	5	6.3	7
	No	1	1	2	2	2	3	3
L		6.5-25	6.5-50	9.5-50	9.5-63	9.5-63	13-75	13-75

CROSS RECESSED RAISED COUNTERSUNK HEAD TAPPING SCREWS

DIN 7983

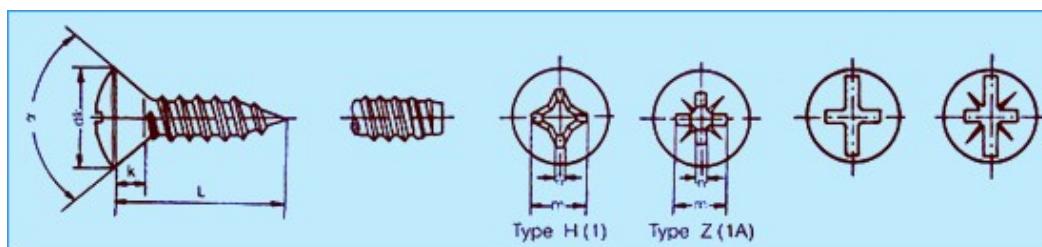

		mm						
Thread size		2.9	3.5	3.9	4.2	4.8	5.5	6.3
dk		5.5	6.8	7.5	8.1	9.5	10.8	12.4
f		0.9	1.2	1.3	1.4	1.5	1.7	2
k		1.7	2.1	2.3	2.5	3	3.4	3.8
Cross	(Type H) m	3.4	4.6	4.7	4.9	5.4	7	7.4
	(Type Z) m	3.1	4.3	4.4	4.6	5.1	6.6	7.1
	No	1	1	2	2	2	3	3
L		6.5-25	6.5-50	9.5-50	9.5-63	9.5-63	13-75	13-75

CROSS RECESSED PAN HEAD TAPPING SCREWS WITH COLLAR

DIN 968

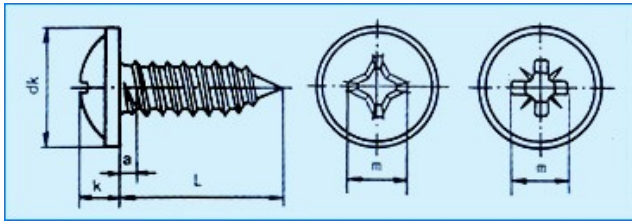

mm

Thread size	ST2.9	ST3.5	ST4.2	ST4.8	ST5.5	ST6.3
dk	7.50	9.00	10.0	11.5	13.0	14.5
k	2.35	2.60	3.05	3.55	3.80	4.55
Cross	(Type H) m	3.00	4.20	4.60	5.00	6.50
	(Type Z) m	2.90	3.90	4.30	4.70	6.20
No	1	2	2	2	3	3
L	6.5-19	9.5-25	9.5-32	9.5-50	13-50	13-50

DRYWALL SCREWS TYPE S PHILLIPS RECESSED BUGLE HEAD TWINFAST

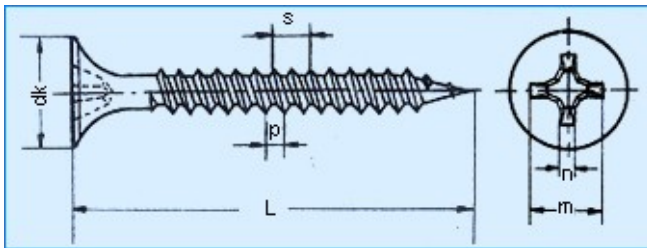

Thread size	Threads/in	dk	Cross recess		L(in)
			No	m	
6	18	8.4	2	4.9	3/4-2 1/2
7	16	8.4	2	4.9	1-2 1/2
8	15	8.4	2	4.9	2-4

HEXAGON WASHER HEAD TAPPING SCREWS

DIN 6928

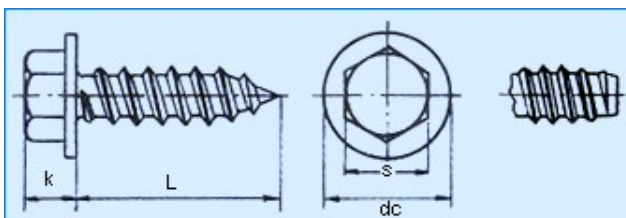

mm

Thread size	ST2.9	ST3.5	ST4.2	ST4.8	ST6.3	ST8.0
dc	6.30	8.30	8.80	10.5	13.5	18.0
k	2.80	3.40	4.0	4.30	5.90	7.00
s	4.00	5.50	7.00	8.00	10.0	13.0
L	6.5-25	6.5-50	9.5-50	9.5-63	13-75	13-75

FERMACELL SCREWS WITH RIBS UNDER THE HEAD

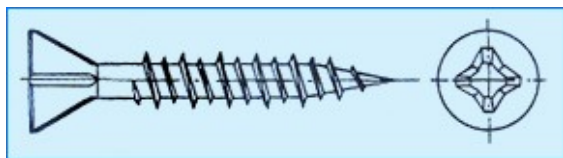

HEX HEAD TAPPING SCREWS

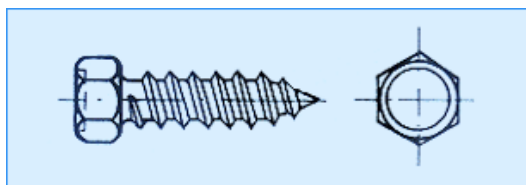

Nominal size	4.2	4.8	5.5	6.3	8#	10#	12#	1/4
Length	9.5-50	13-75	16-100	16-120	3/8-2	1/2-3	3/4-4	3/4-5

HEX FLANGE HEAD SELF-TAPPING SCREWS

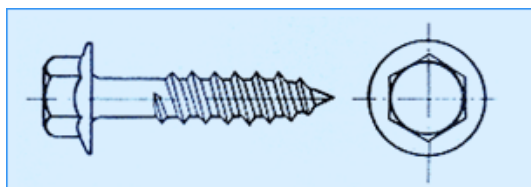

Nominal	5.5	6.3	12#	14#
Length	16-120	16-180	16-120	16-180

HEX FLANGE HEAD TYPE 17 SCREWS

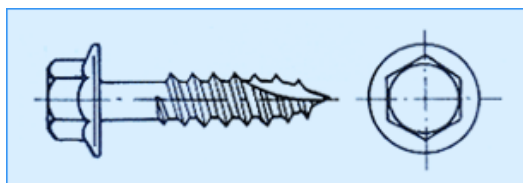

Nominal	12#	1/4	5.5	6.3
Length	1-5	1 1/2-5	25-120	30-120

PINS, RIVETS AND ANCHORS

SPLIT PINS

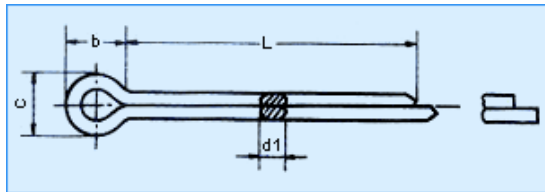
DIN 94

Nominal	2	2.5	3.2	4	5	6.3	8	10
d1	1.8	2.3	2.9	3.7	4.6	5.9	7.5	9.5
b	4	5	6.4	8	10	12.6	16	20
c	3.2	4	5.1	6.5	8	10.3	13.1	16.6
L	10-40	12-50	18-80	20-125	20-125	28-140	36-140	56-140

mm

SPLIT PINS

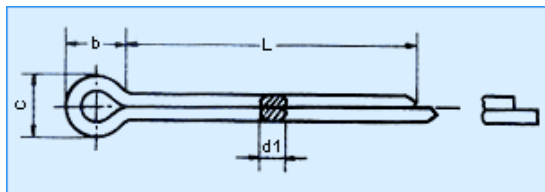
ISO 1234

Nominal	1	1.2	1.6	2	2.5	3.2	4	5	6.3	8	10
d1	0.8	0.9	1.3	1.7	2.1	2.7	3.5	4.4	5.7	7.3	9.3
b	3	3	3.2	4	5	6.4	8	10	12.6	16	20
c	1.8	2	2.8	3.6	4.6	5.8	7.4	9.2	11.8	15	19
L	6-20	8-20	8-20	10-20	12-50	18-80	20-80	20-80	28-80	36-80	56-80

mm

COTTER PINS

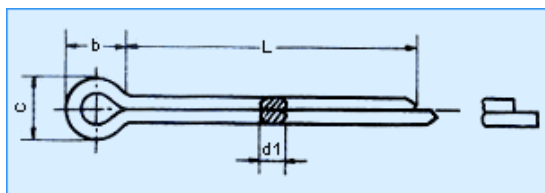
B.S.

Nominal	3/32	7/64	1/8	9/64	5/32	11/64	3/16	7/32	1/4	9/32	5/16	3/8
d1	2.11	2.57	2.70	3.36	3.51	4.09	4.40	5.29	5.69	6.86	6.29	9.10
b	4.83	5.59	6.35	7.11	7.87	8.64	9.65	11.18	12.7	14.22	15.75	19.05
c	4.72	5.48	6.29	7.11	7.87	8.68	9.44	11.07	12.64	14.22	15.97	18.94
L(in)	3/8-7/8	3/8-2	1/2-3	1/2-3	5/8-3	5/8-3	5/8-3	3/4-3	3/4-3	1 1/2-3	1 1/2-3	1 1/2-3

inches

BLIND RIVET

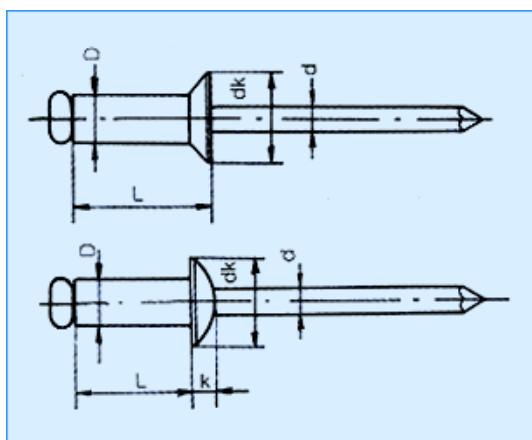

Nominal	3	3.2	4	4.8	5
L	4.8-16	4.8-18	4.8-22	6.4-30	6.4-30
dk	6	6	8	9.5	9.5
k	1	1	1.4	1.5	1.5
d	1.8	1.8	2.2	2.6	2.8

mm

SEALED TYPE ALUMINIUM BLIND RIVET

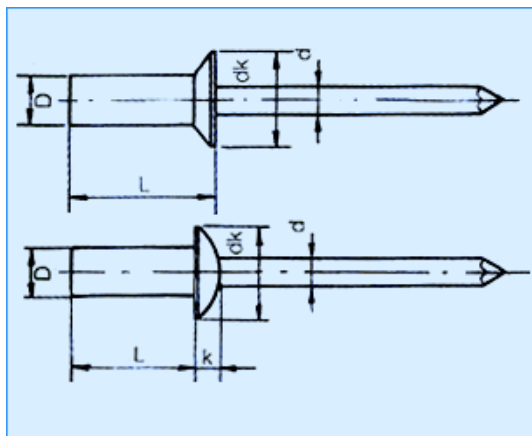

Nominal	3.2	4	4.8	5
L	5-18	5-22	8-30	8-30
dk	6	8	9.5	9.5
k	1	1.4	1.5	1.5
d	1.7	2.2	2.64	2.8

mm

BOLT ANCHORS

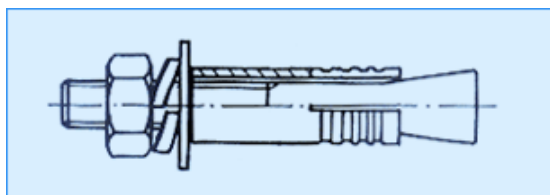

Thread size	M6	M8	M10	M12	M16	M20	M22	M24
-------------	----	----	-----	-----	-----	-----	-----	-----

CUT ANCHORS

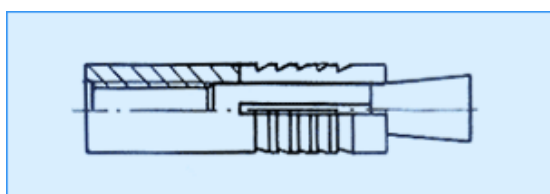

Thread size	M6	M8	M10	M12	M16	M20	M22
Length	30	35	40	52	63	83	93

mm

SLEEVE ANCHORS

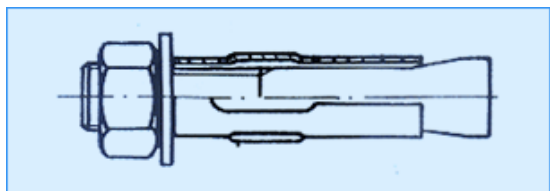

Nominal size	6.5	8	10	12	16	20
--------------	-----	---	----	----	----	----

mm

WEDGE ANCHORS

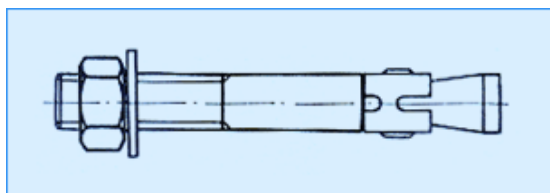

Thread size	M6	M8	M10	M12	M16	M20
Length	49-95	50-220	65-250	75-250	90-250	90-300

mm

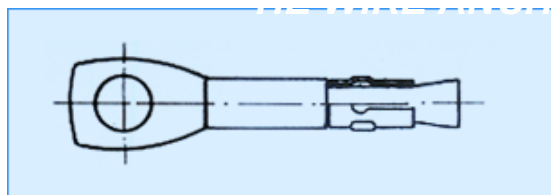

Nominal size	mm	
	6	6
L	60	67

DROP IN ANCHORS

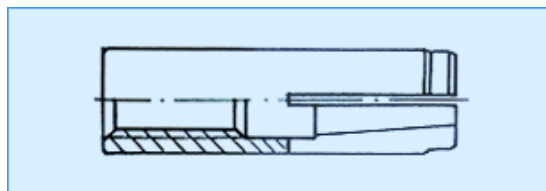

Thread size	mm					
	M6	M8	M10	M12	M16	M20
Length	25	30	40	50	65	80

HEAVY-DUTY SHELLANCHOR

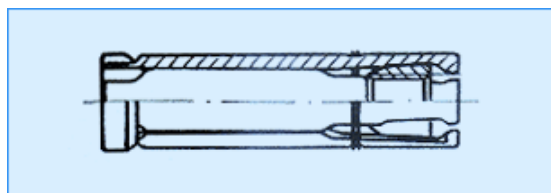

Thread size	mm					
	M6	M8	M10	M12	M16	M20
Length	45	55	60	75	115	130

NYLON HAMMER FIXING

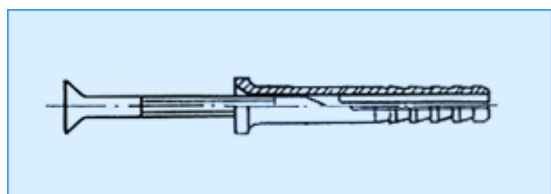

Nominal size	mm		
	5	6	8
Length	20-50	35-80	60-135

THREADED RODS AND OTHERS

THREADED ROD

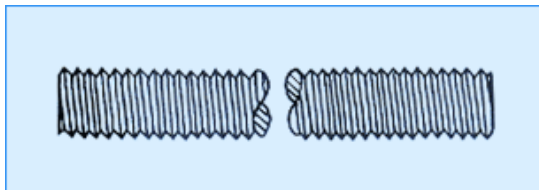

Thread size	M6	M8	M10	M12	M14	M16	M18	M20	M22	M24
LENGTH	1000mm-40000mm									

mm

Thread size	1/4	5/16	3/8	7/16	1/2	9/16	5/8	3/4	7/8	1
LENGTH	3feet-12feet									

inches

WIRE ROPE CLAMPS

DIN 741

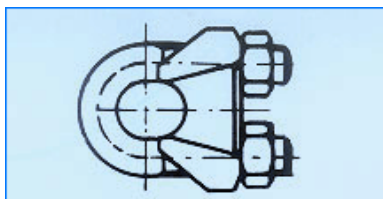

for rope dia	3	5	6.5	8	10	11	13	14	16
Thread size	M4	M5	M5	M6	M8	M8	M10	M10	M12

mm

HEX HEAD PIPE PLUGS

DIN 910

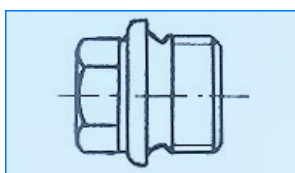

Thread size	M10	M12	M14	M16	M18	M20	M22	M24	M26	M30	M36
-------------	-----	-----	-----	-----	-----	-----	-----	-----	-----	-----	-----

STEEL PIPE SCAFFOLD

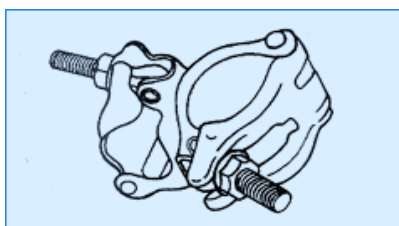

GREASE FITTING

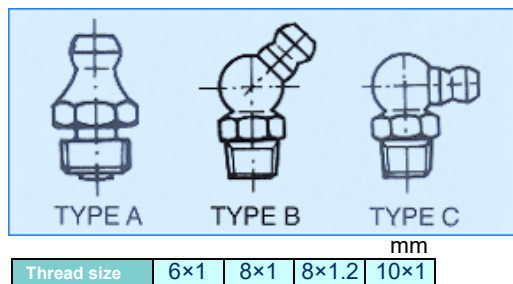

RELATED PRODUCTS

[Washers](#), [Screws and bolts](#), [Nuts](#), [Threaded rods](#), [Gas springs](#),

CONTACT:

In **Gestión de Compras** work with a wide range of customers from different sectors but have in common the search for products that suit your needs at the best Price and the guaranteed maximum quality. Check with us about any product. We have a qualified staff who will advise you.

C/ Marzo, 9

02002 Albacete (Spain)

Phone: + (34) 967 221 602

Fax: + (34) 967 223 369

Email: info@gestiondecompras.com